

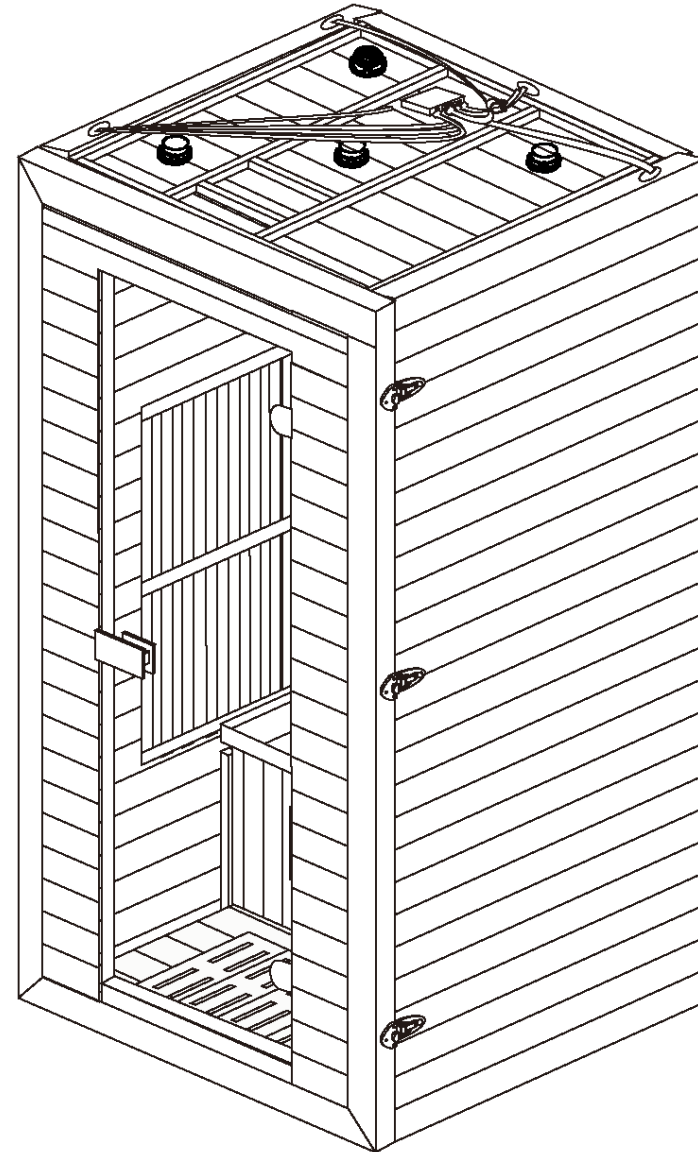

INSTALLATION MANUAL

KY008 Infrared Sauna Series



30 Day Technical Support:

Call **01908 317512** and request technical support for aiding your installation.

Replacements Parts: Inside of your warranty period visit:

<https://www.insigniashowers.com>, click support and make a warranty claim.

Spares/Replacements Parts: Outside of your warranty period visit

<https://www.insigniashowers.com/replacement-parts.html>

ATTENTION INSTALLERS:

These instructions must be left with the customer

CHECK ALL CONTENTS BEFORE BUILD COMMENCES. NO RETURNS CAN BE MADE ONCE THE BUILD HAS STARTED AS IT IS DEEMED ACCEPTANCE OF PRODUCT!

Contents

Thank you for your purchase	3
Electrical & Tool requirements	4
Box contents	5
Screw Pack Contents	6
Sauna Left Panel and Back Panel Install	7
Bench Heater Install	8
Bench Front Install	9
Heater Wires Install	10
Right Panel Install	11
Bench Cover Install	12
Back Rest Install	13
Glass Panels Install	14
Heater Cover Install	15

Front Panels Install	16
Roof Install	17
Door Cushioning Strip Install	18
Roof Cover Install	19
Door Handles Install	20
Door Magnet Brackets Install	21
Securing the Electrics	22
Electrical Connections	23
Sauna Control Panel Instructions	24
Remote Control Panel	26
Sauna Room Safety Guide	27
WEEE Compliance Statement	28

*Thank
You*

Thank you for your recent purchase of an Insignia Sauna. Please read this booklet with great care to ensure you get the best out of your build and have a Sauna that will last for many years to come! Like everything, in order to obtain a first class product that will serve you well for many years, the effort and correctness put into the assembly will reflect in the quality of your finish.

Electrical Requirements Model KY008

Voltage Rating 220-240AC

Frequency Rating 50Hz

Power Rating 1900 Watts Sauna

Total Amperage 8.0 amps

Indoor saunas with power consumption under 3KW have been designed for easy installation, allowing for a simple plug-in directly into a standard household power circuit.

Installation Notes:

1. (Recommended) Consult with a qualified Electrician before connection to assess suitability.
2. Ensure all parts are connected safely and correctly.

Always use protection against electrical surges by means of an RCD unit.

If you are uncertain about the installation process or have any questions, please feel free to reach out to our friendly technical support for general advice. For anything more specific to the electric installation, please consult with a certified electrician.

Tools Required

- Scissors
- Knife
- Spirit Level
- Tape Measure
- Philips Screwdriver
- Electric Drill
- Safety Gloves
- Safety Glasses

What's in the Boxes?

Contents	Quantity	✓
Roof	1	[]
Top Board	1	[]
Left Panel	1	[]
Back Panel	1	[]
Right Panel	1	[]
Front Panel & Glass Door	1	[]
Bench Front Cover	1	[]
Infrared Heater	1	[]
Bench Top Seat	1	[]
Door Handle	1	[]
Floor Insert	1	[]

VERY IMPORTANT

Have you got everything? If not please contact the Insignia directly on **01908 317 512**. Remember **NEVER** book your tradesman until everything has arrived, been checked and is present. No replacement/missing parts can be obtained free of charge during or after the build. Any claims can only be within the timescale permitted (48 hours after delivery) and always **BEFORE** build.

Screw Pack Contents

Contents	Quantity	✓
ST 50mm Screws	12	[]
ST 35mm Screws	2	[]
ST 18mm Screws	16	[]
ST 12mm Screws	10	[]
M 45mm Bolts	2	[]
Wire Fixers Ø8mm	7	[]
Wire Fixers Ø10mm	3	[]
Nuts and Washers	4	[]
Rubber mats	4	[]
Cable splinter	1	[]

VERY IMPORTANT

Have you got everything? If not please contact the Insignia directly on **01908 317 512**. Remember **NEVER** book your tradesman until everything has arrived, been checked and is present. No replacement/missing parts can be obtained free of charge during or after the build. Any claims can only be within the timescale permitted (48 hours after delivery) and always **BEFORE** build.

Step 1 — Installing the Back and Left Panels

Place the left and back panel in line and hook the clip onto the knob and secure by pushing down the lever.

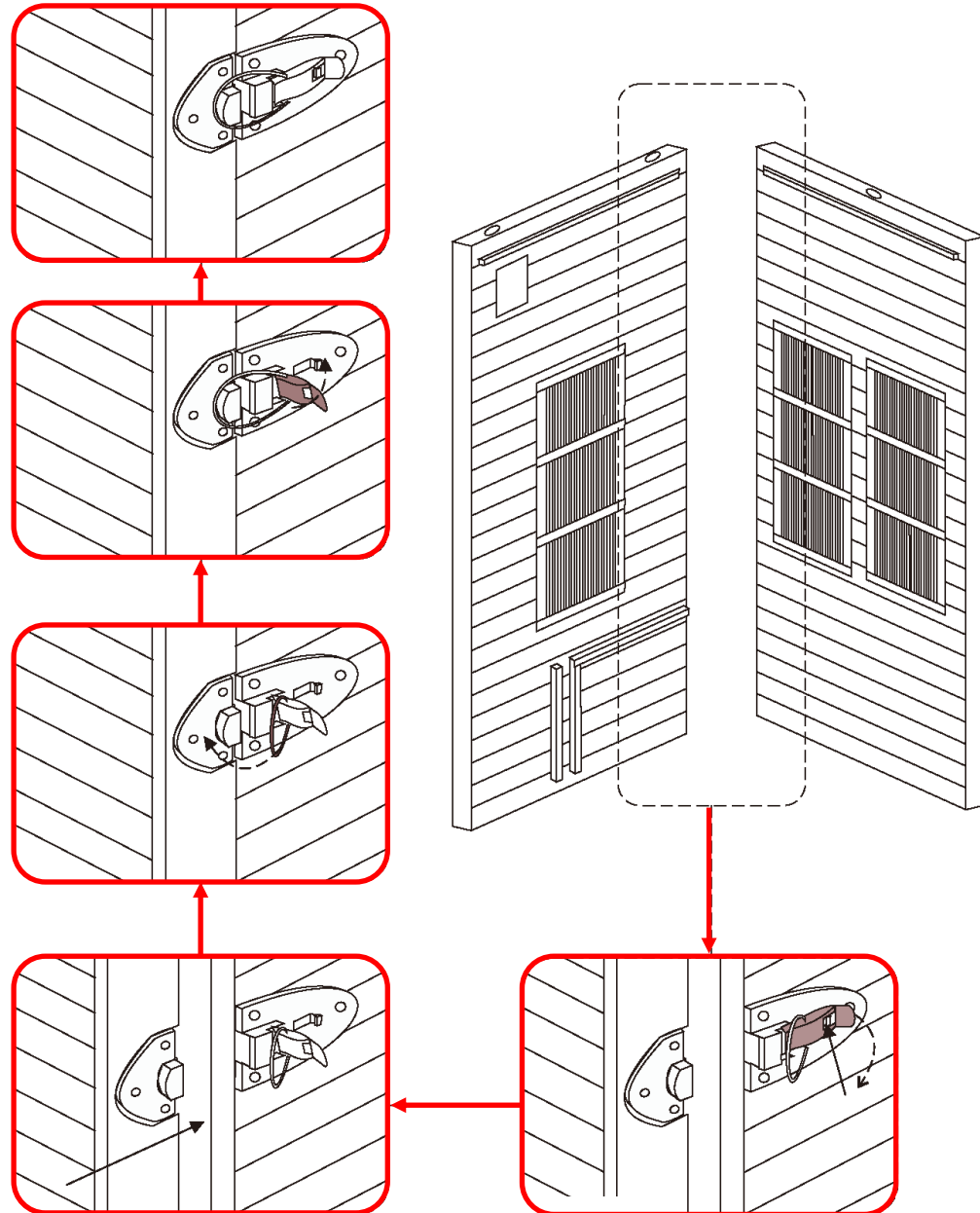

Step 2 — Installing the Floor

Place the floor of the sauna in line with the fitted back and left panel.

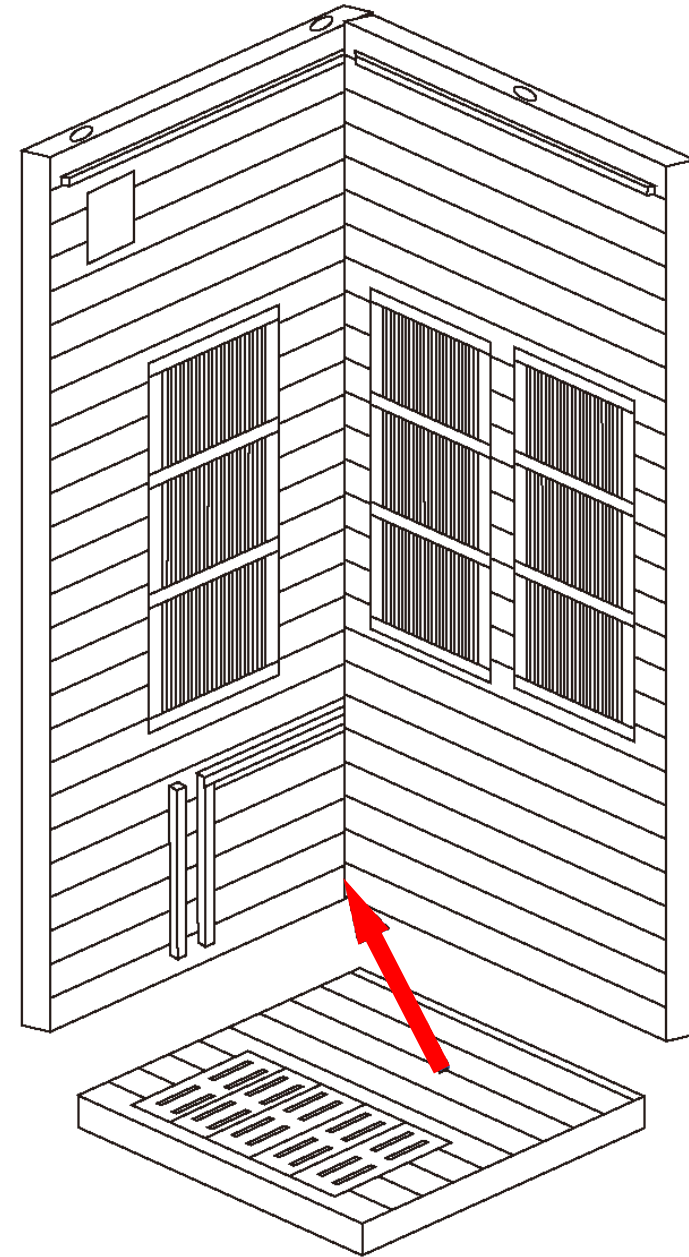

Step 3 — Installing the Bench Heater

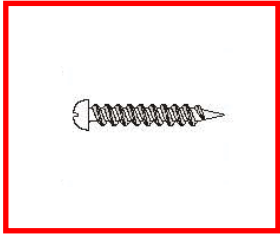

4 x ST4 18mm Screws

4 x Rubber Pads

Using the ST4 18mm screws and the Rubber pads found in the screw pack, connect the bench heater behind the bench frame as shown in the diagram.

Ensure the rubber pads are positioned between the wood and the metal legs of the infrared heater.

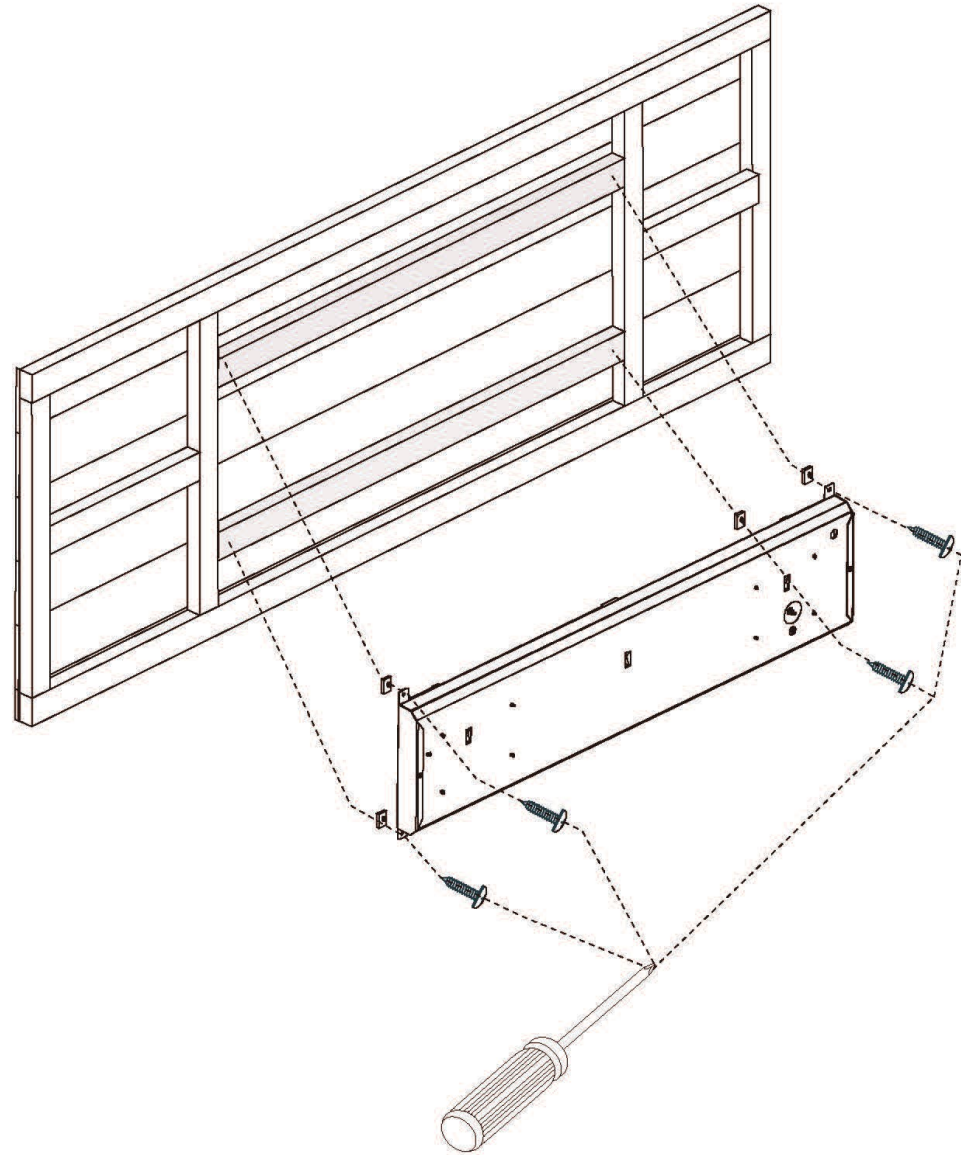

Step 4 — Installing the Bench Front Panel

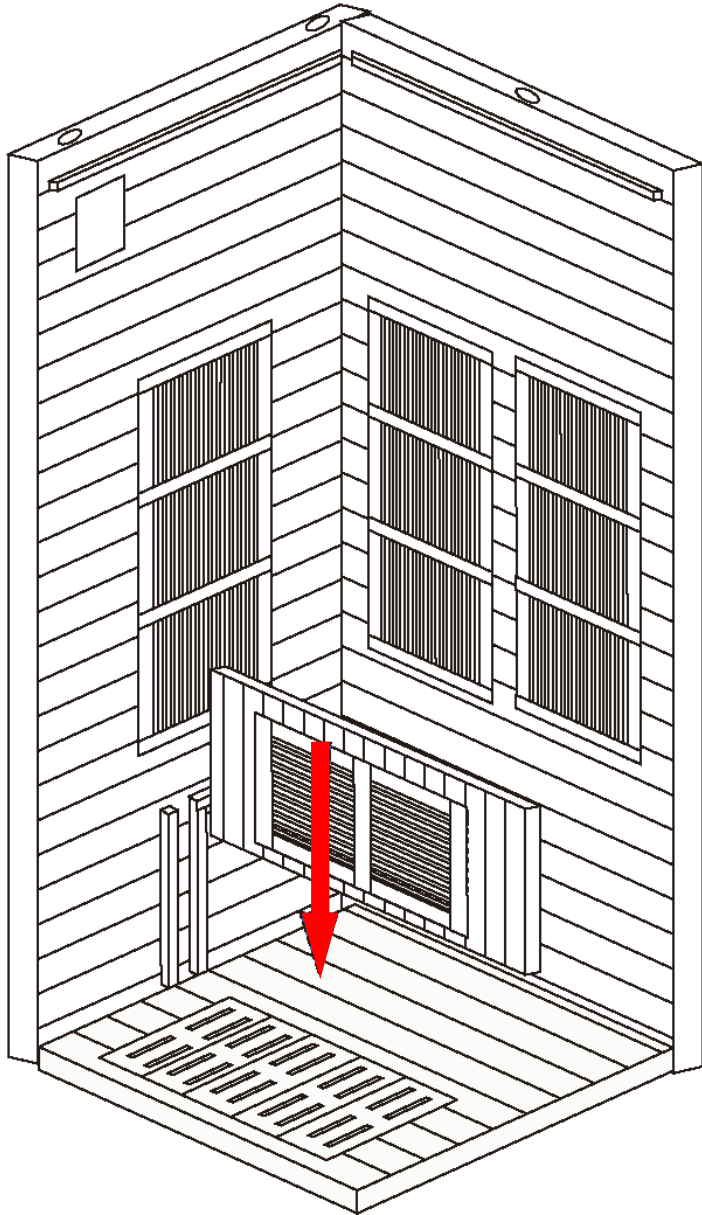

Slot the bench front panel between the grooves and fit into place.

Step 5 — Connecting the Heater Wires

Once the bench panel is in place, locate the splinter cable in the screw bag & connect the heater wires as shown in the diagram. If supplied, secure the earth wire on the back of the heater under the bolt.

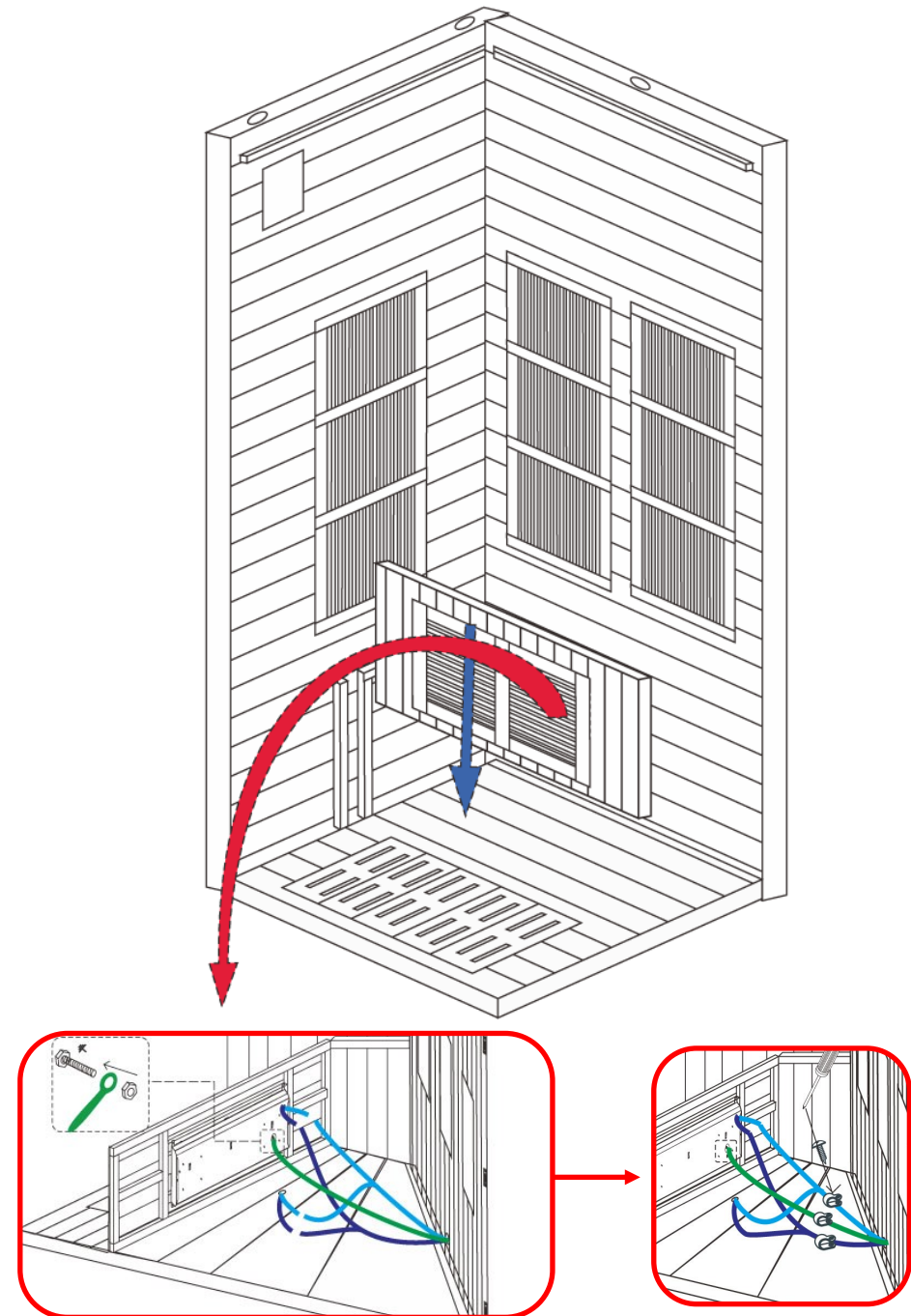

Step 6 — Installing the Bench Seat

Slide the bench top between the grooves and push till secure against the back and left panels.

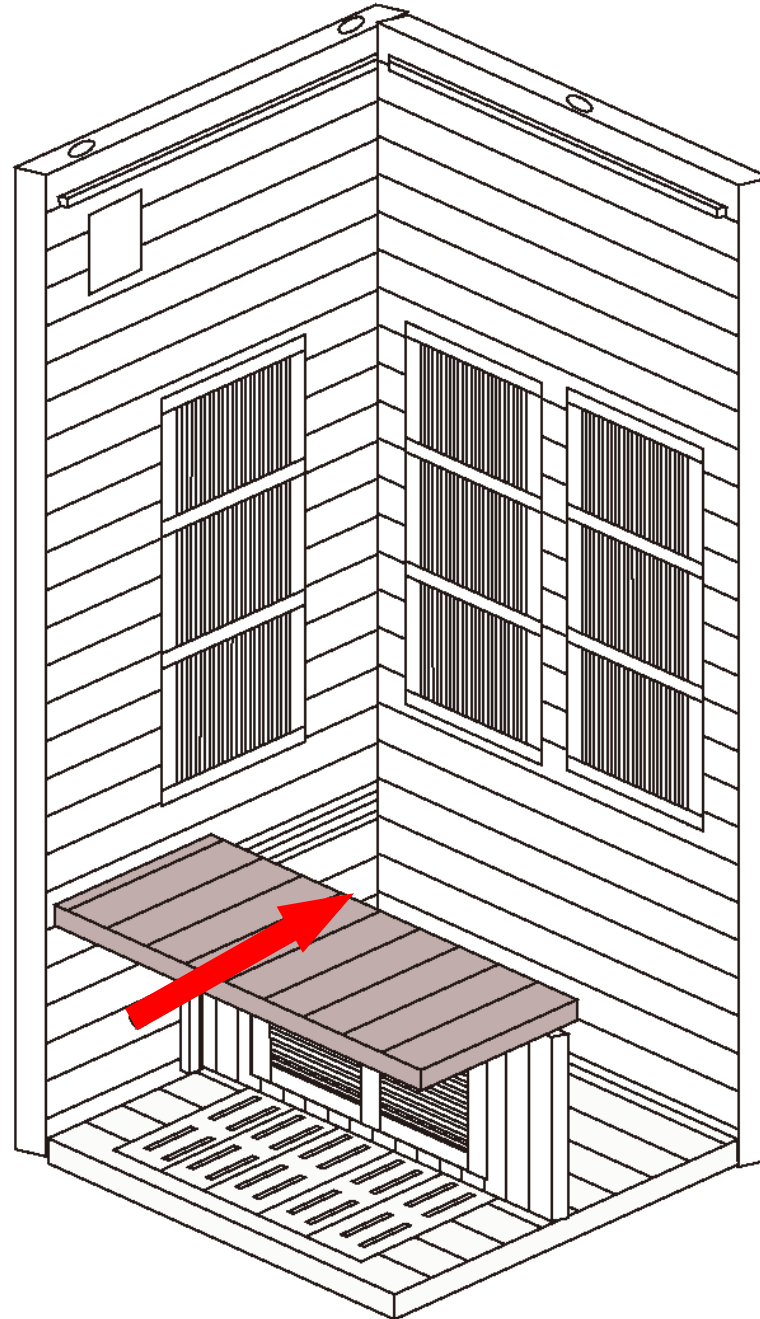

Step 7 — Installing the Right Panel

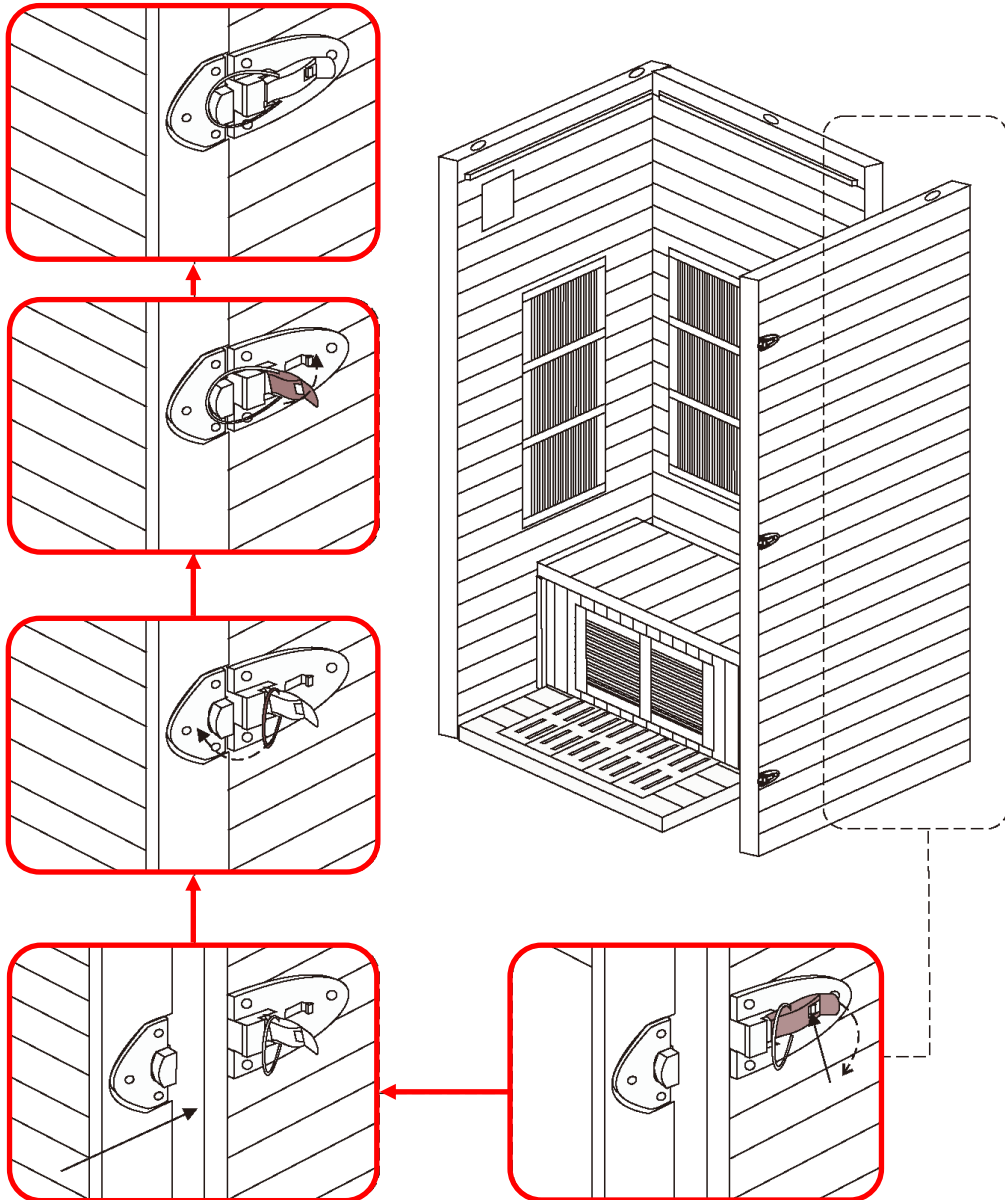

Repeat step 1 with the right panel.

Step 8 — Installing the Door Panel

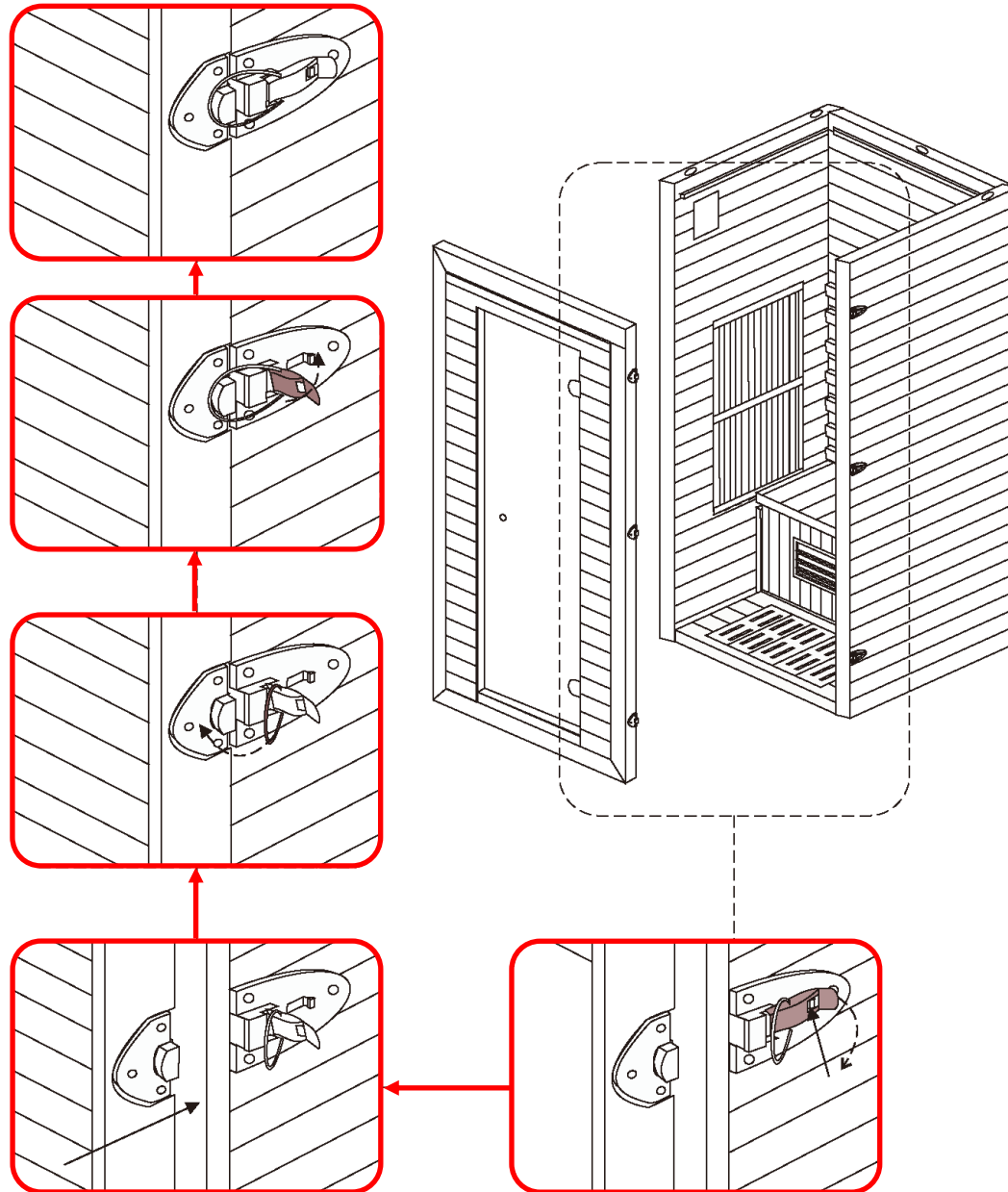

Place the door panel in line with the latches and secure with locking the latches.

Step 9 — Installing the Door Handles



2 x M45mm

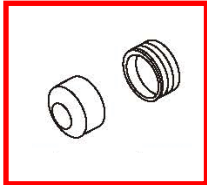

2 x Nuts and Washers

Connect the front piece and the first part of the back piece for the inside of the door, and tighten using the nuts. Connect the second part of the back piece and secure using the M 45 screws.

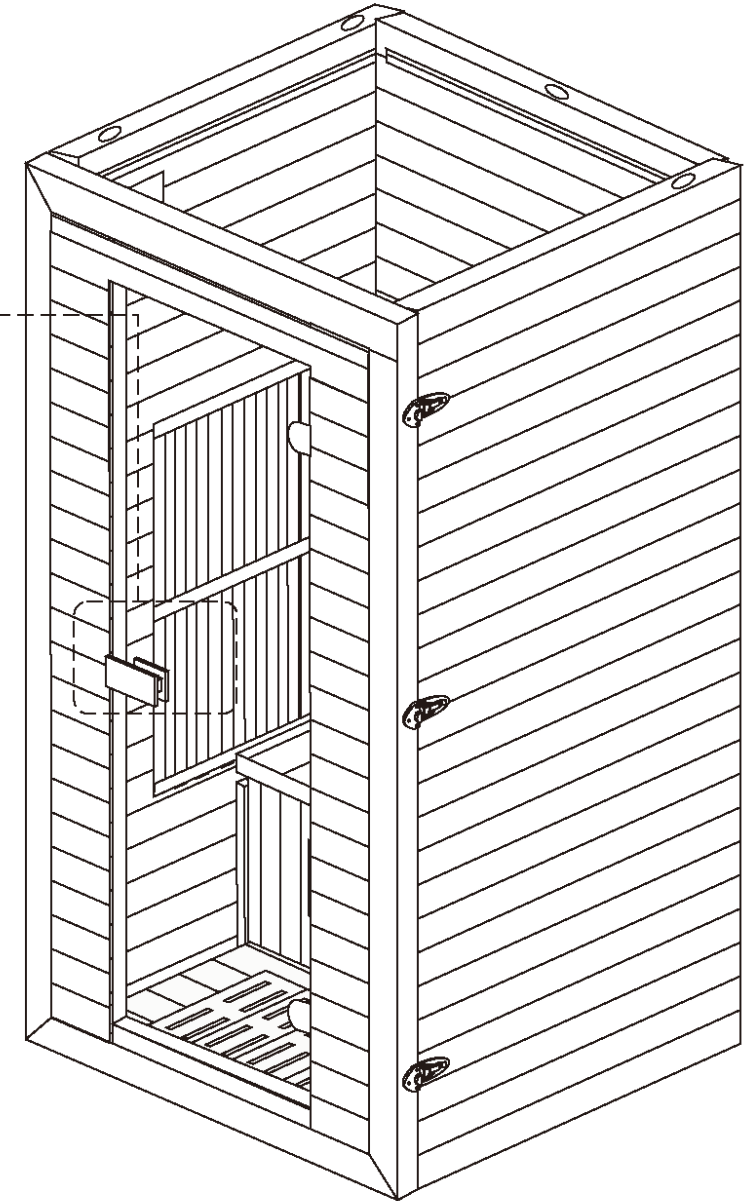
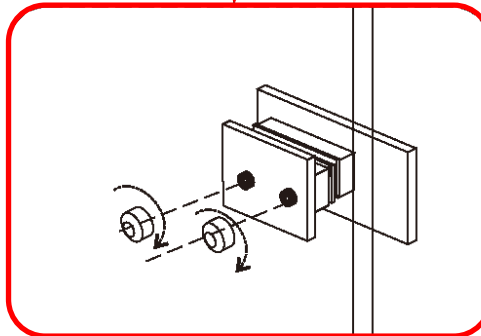
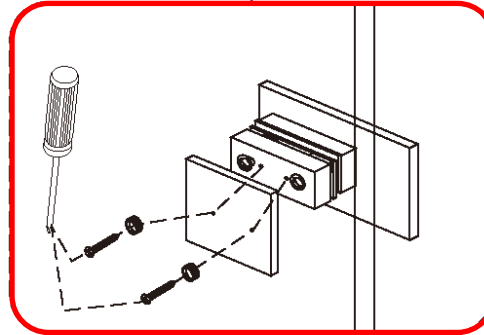
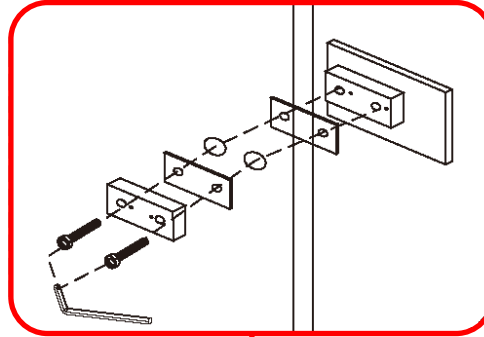

Step 10 — Installing the Roof

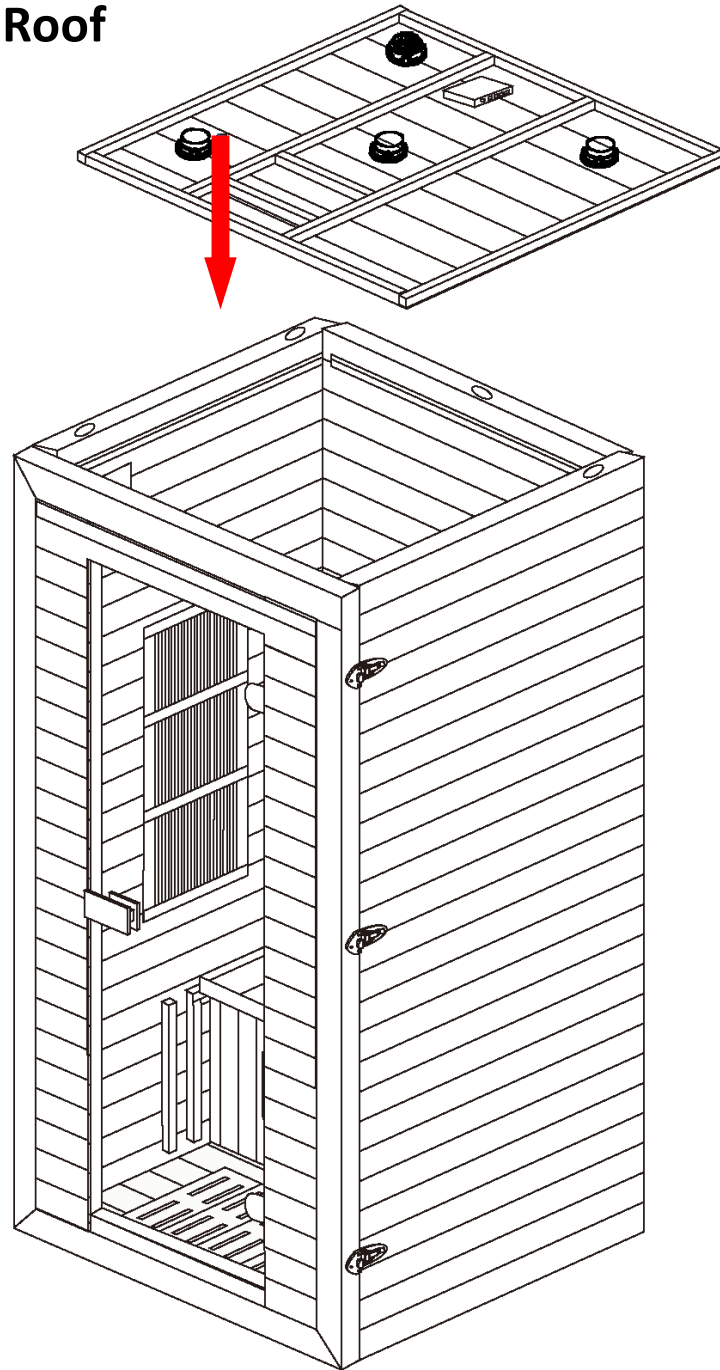

Carefully place the roof into the remaining space making sure it is resting on all sides of the fitted ledges.

Step 11 — Connecting the Electrics

Connect the wires of the main power, control box, temperature control and ozone.

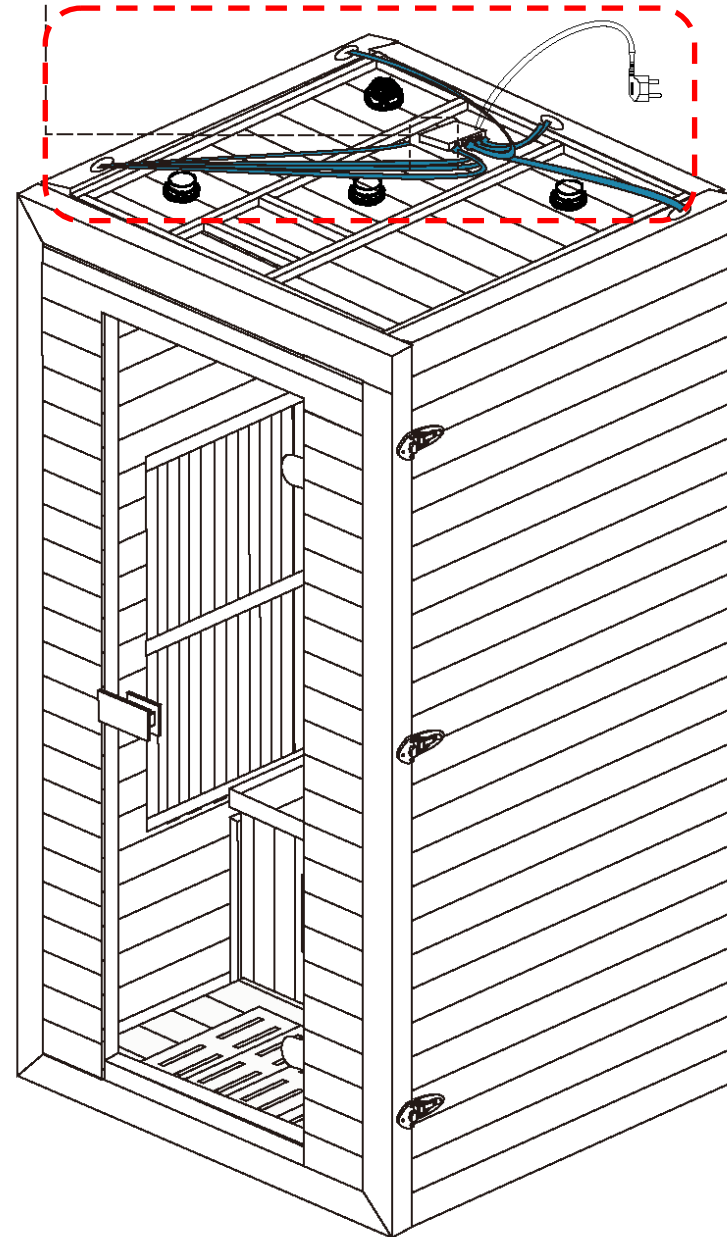
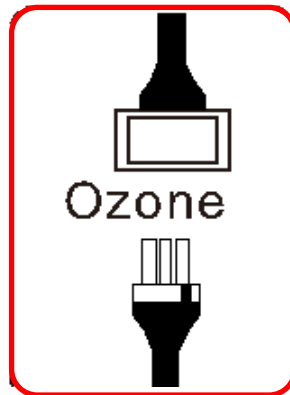
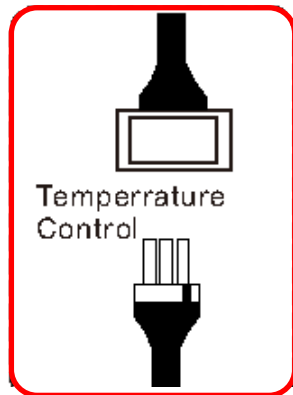
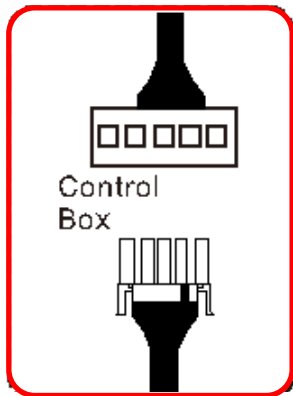

Step 12 — Securing the Roof

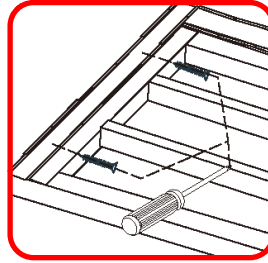

8 x ST 50mm

Secure the roof by screwing in the ST 50mm screws.

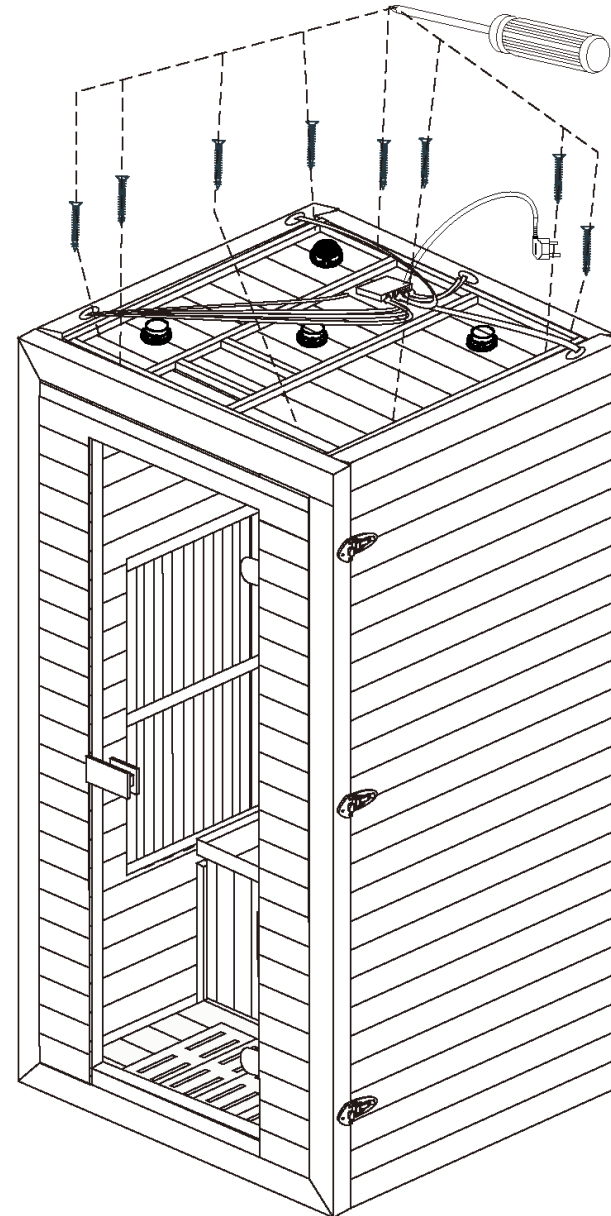

Step 13 — Installing the Wire Fixers

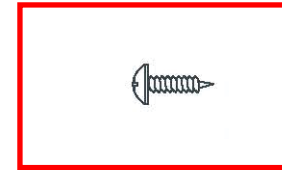
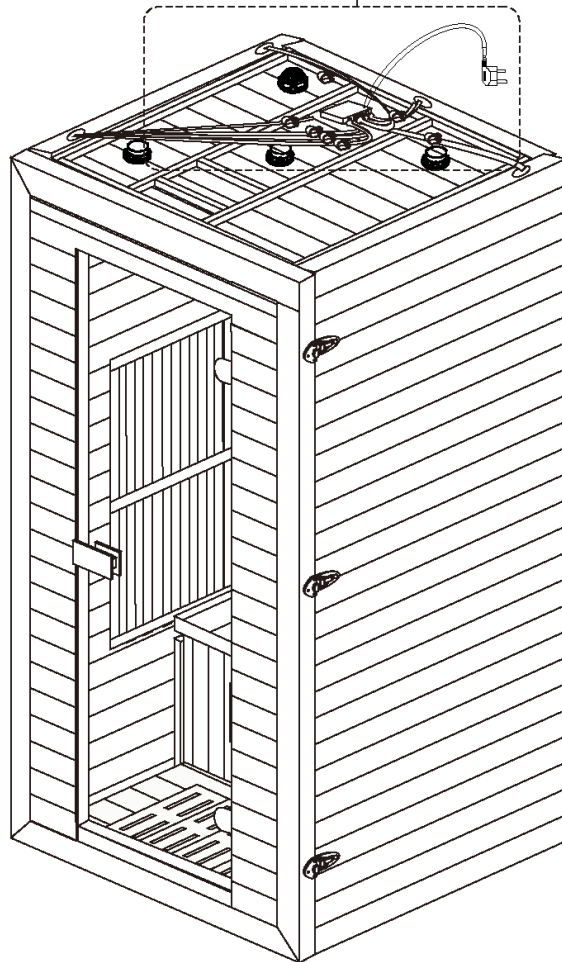
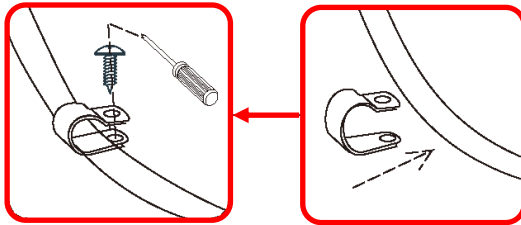

5 x ST 12mm

Use the rubber bands to secure the wires to the roof using the ST 12mm screws.

Step 14 — Electrical Connections

1. Main Power Supply
2. Group A : Connections for back and leg heater
3. Group B : Connections for front and side heater
4. Temperature Detector Wire
5. USB Input
6. Temperature Controller Wire
7. Antenna
8. Speaker Wires
9. Fan Wire
10. Ozone
11. Roof Light
12. CD/MP3 Wire
13. Control Panel Wire
14. AC220V Power Cord
15. Chromatherapy Lighting

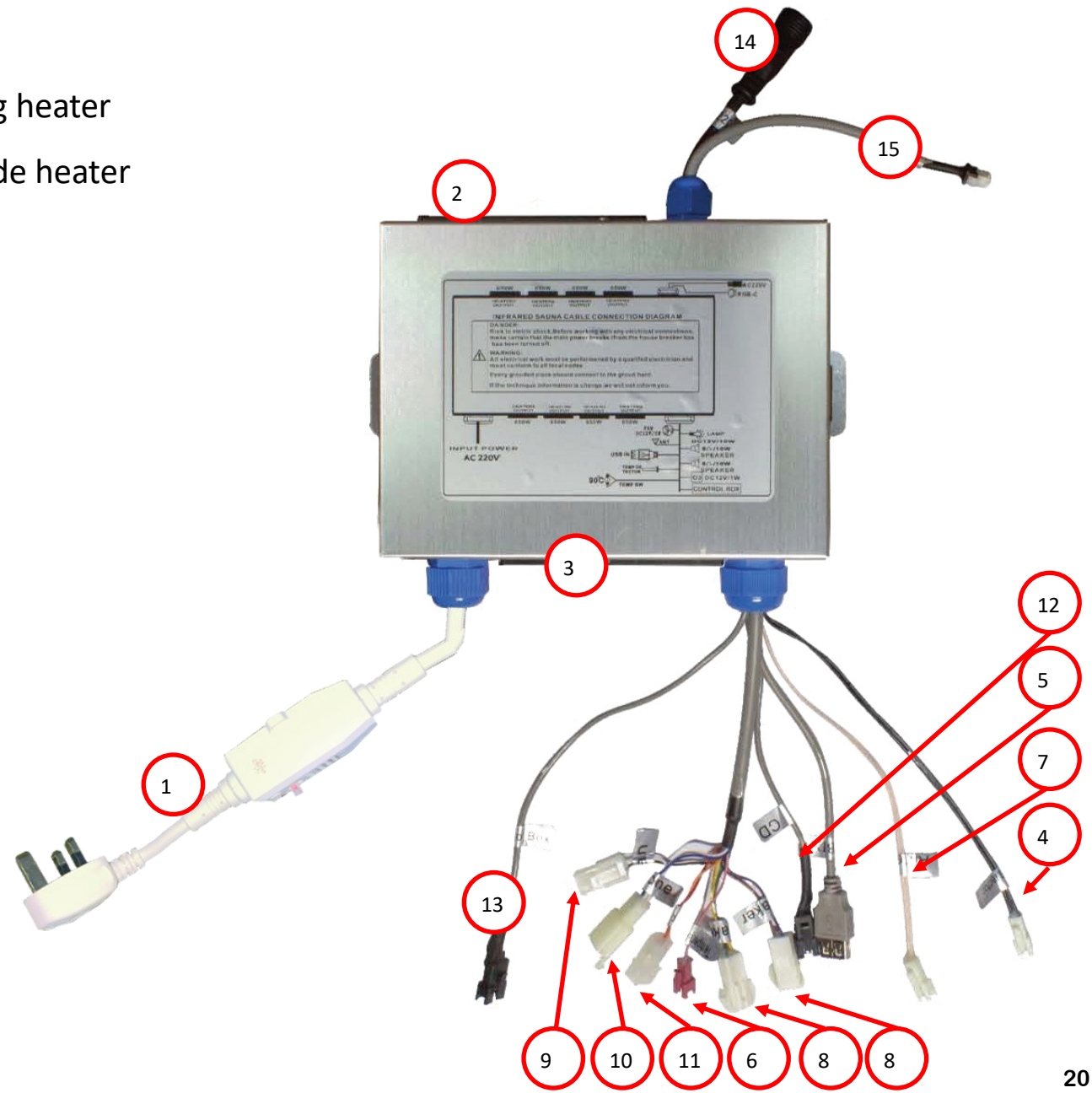

Sauna Control Panel Instructions

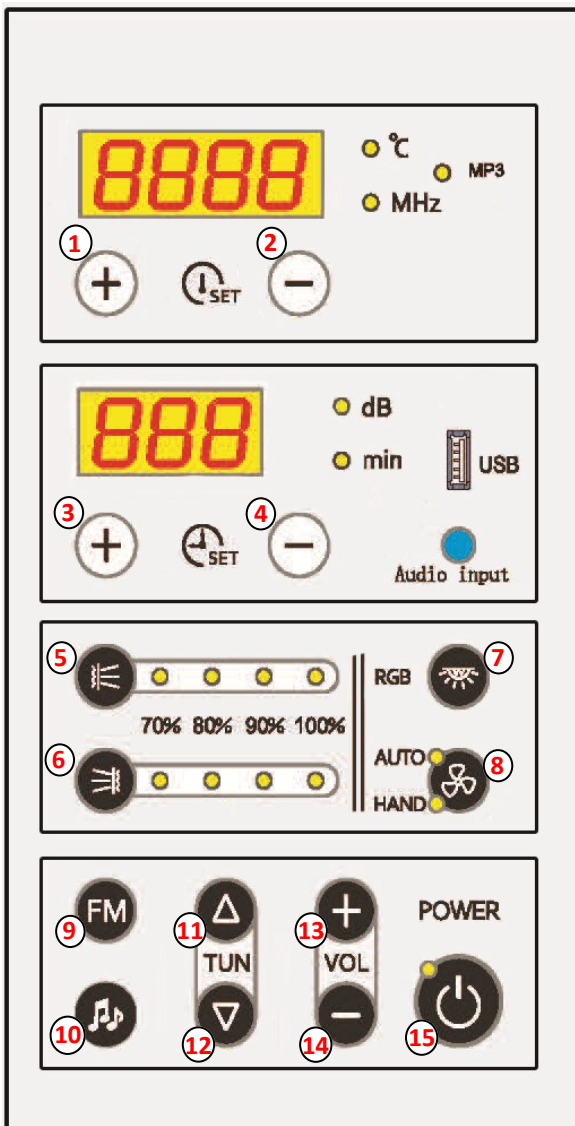

Button 1/2 (+/- Temp)

Cycle through desired temperature setting (max 60°C)

Button 3/4 (+/- Time)

Cycle through desired time setting (max 99 mins)

Button 5/6 (Sauna Heaters)

Press to activate Sauna heaters. Pressing once will put the heaters on at 100%. Twice = 90%. Three times = 80%. Four times = 70% and five times = Off.

Button 7 (Lights)

Press to cycle through the coloured lights. Each press will change colour until a full cycle is completed and they turn off.

Button 8 (Fan)

Press to turn the fan on, press again to turn it to auto and then a third time to turn it off.

Button 9 (FM)

Press to turn on the radio. Press and hold to auto tune the radio stations. To change radio station press tune.

Button 10 (Audio Function)

Cycle through the audio function settings, MP3, USB, Bluetooth or AUX. When playing music through Bluetooth or USB simply use Tune (Button 11/12) to change track.

Button 11/12 (Tune)

Press and use the +/- to manually search. Hold the buttons down for two seconds to speed scroll.

Button 13/14 (Volume)

Press to cycle through the volume either up or down.

Button 15 (Power)

Use to power the control panel on or off.

Remote Control Instructions

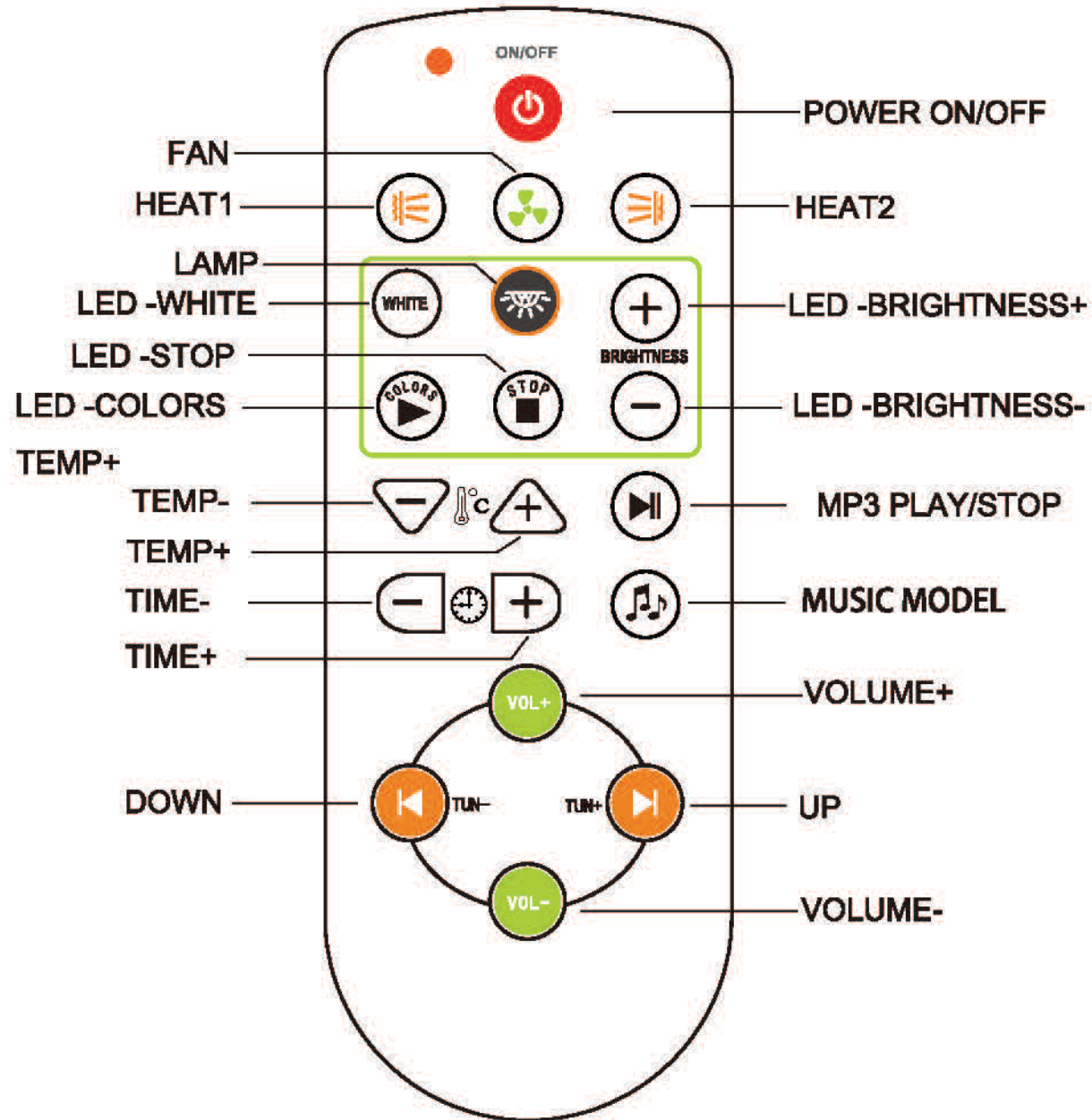

Sauna Usage & Safety Guide

1. Never leave children unattended in the Sauna.
2. Regulate (if preferred) the temperature of sauna before session - Pre-heat time 15-30 minutes (from room temperature 20c)
3. Never touch the heater panels whilst in operation, possible burning may occur.
4. Recommended time of use is a maximum of 15 mins initially. We highly recommend working up in time to this, beginning with 5 minute sessions to get your body used to using a sauna.
5. Stay hydrated during each sauna session.
6. Exit the sauna immediately if feeling dizzy, faint or short of breath.
7. Do NOT use the sauna function if you're pregnant, have a heart condition, have low or high blood pressure. If you're unsure consult your GP before use.
8. If you have any underlying health conditions which you feel could be aggravated by an increase in temperature, consult your GP before use.
9. If you begin to have any issues with your health after using a sauna, stop immediately and consult your GP regarding your symptoms before continuing to use.
10. Consult your GP before using the steam room if you're on medication at all, especially with drowsy side effects.
11. Never use the sauna if you have been drinking alcohol or under the influence of other substances.
12. Do not put combustible material on the heaters at any time.
13. Always turn power supply off after use.

WEEE Compliance Statement

The UK Waste Electrical and Electronic Equipment (WEEE) regulations came into force on 2 January 2007. Under this new legislation, producers of electrical and electronic equipment (EEE) have to fulfil certain obligations.

Under the WEEE directive Insignia is considered the producer of certain products we supply and in line with the demands of the legislation we are pleased to offer the opportunity to return these products to us for treatment and recycling.

Insignia products will generally have an identifying mark and the common crossed out wheelie bin label. We accept returns of all products carrying the Insignia brand. All other products are either considered outside the scope of WEEE or Insignia is not technically the producer of these products. Insignia also accepts historic like-for-like WEEE returns. All WEEE returned to Insignia will be recycled in appropriate treatment and recycling centres in accordance with the legislation. If you wish to return any products to us, please send your item(s) to our head office.

Company Contract No. 326457

WEEE Producer No. CBDU64227

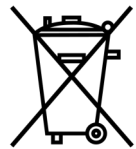

LABELLING

Products labelled with the WEEE symbol (a crossed out “waste bin”) indicate that the final user should not discard this product along with other household waste, but that it must be collected and treated separately.



Returns Address for WEEE

Insignia

9a Deans Road, Old Wolverton, Canon Industrial Park, Milton Keynes, Buckinghamshire, MK12 5NA, UK



EU – Declaration of Performance

Insignia declares that all its products complies with the essential requirements and other relevant provisions of Directive 305/2011/EC. A copy of the Declaration of performance is available from www.insigniashowers.com/ce-certification

Insignia™ is a registered trademark of Maclean International Ltd, 9a Deans Road, Old Wolverton, Canon Industrial Park, Milton Keynes, Buckinghamshire, MK12 5NA, UK

All images are subject to copyright. Images may not be used in any way shape or form with out written permission from Maclean International Ltd. Images are NOT permitted to be saved, printed or uploaded. Violation of copyright laws are punishable by law.

All images are registered with
ImageTraker

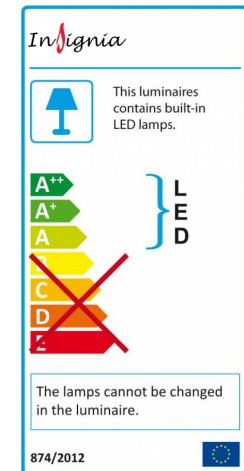

Insignia™ is a registered trademark of Maclean International Ltd

All images are subject to copyright. Images may not be used in any way shape or form with out written permission from Maclean International Ltd. Images are NOT permitted to be saved, printed or uploaded. Violation of copyright laws are punishable by law.