

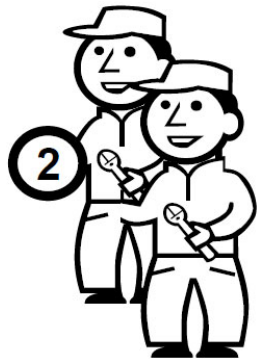

INSTALLATION MANUAL

KY2216

Sauna Series



30 Day Technical Support:

Call **01908 317512** and request technical support for aiding your installation.

Replacements Parts: Inside of your warranty period visit:

<https://www.insigniashowers.com>, click support and make a warranty claim.

Spares/Replacements Parts: Outside of your warranty period visit

<https://www.insigniashowers.com/replacement-parts.html>

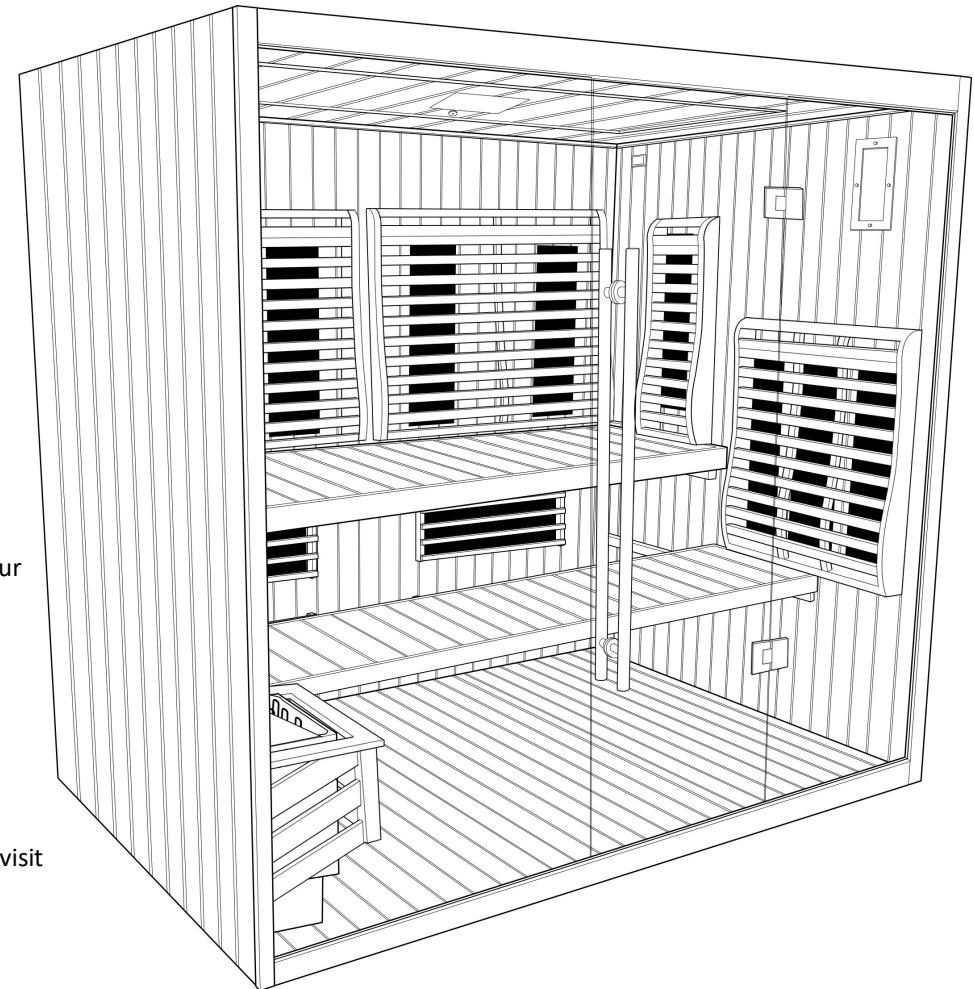

ATTENTION INSTALLERS:

These instructions must be left with the customer

CHECK ALL CONTENTS BEFORE BUILD COMMENCES. NO RETURNS CAN BE MADE ONCE THE BUILD HAS STARTED AS IT IS DEEMED ACCEPTANCE OF PRODUCT!

Contents

Thank you for your purchase	3
Electrical & Tool requirements	4
Box contents	5
Roof Connection	6
Roof Lights Installation	8
Roof Connection 2	9
Floor Connection	10
Back Panel Connection	11
Side Panel Connection	13
Right Side Panel to Back Panel Install	14
Left Side Panel Install	15
Lower Heater Guard Install	16
Heater Guard Install (Right Panel)	17
Heater Guard Install (Back Panel)	18
Upper Bench Install	19
Lower Bench Support Install	20
Lower Bench Install	21

Connecting the Front Framework	22
Framework Install	23
Door Handle Install	24
Door Hinge Install	25
Door Install	26
Electrical Connections	28
Control Panel Instructions	29
Sauna Room Safety Guide	31
WEEE Compliance Statement	32

*Thank
You*

Thank you for your recent purchase of an Insignia Sauna. Please read this booklet with great care to ensure you get the best out of your build and have a Sauna that will last for many years to come! Like everything, in order to obtain a first class product that will serve you well for many years, the effort and correctness put into the assembly will reflect in the quality of your finish.

Electrical Requirements Model KY2216

Voltage Rating 220-240AC

Frequency Rating 50Hz

Power Rating 3600 Watts

Amperage 15 Amps

Always consult a qualified Electrician before connection as to suitability Your electrical contractor will understand ALL legal requirements of connection before undertaking any work or installation.

UNDER NO CIRCUMSTANCES UNDERTAKE THIS YOURSELF. ALWAYS USE AN ELECTRICAL CONTRACTOR AND ENSURE LEGAL CERTIFICATION IS GIVEN ON COMPLETION

The KY2216 has provision for 240 volts. Your qualified electrician will advise on the method they feel best suits your situation and electrical supply along with any potential benefit either may have.

Tools Required

- Scissors
- Knife
- Spirit Level
- Tape Measure
- Philips Screwdriver
- Electric Drill
- Safety Gloves
- Safety Glasses

What's in the Boxes?

Contents	Quantity	✓	Contents	Quantity	✓
Inner Roof Piece	3	[]	Front Framework Piece	4	[]
Floor Piece	3	[]	Large Fixed Glass	1	[]
Outer Roof Perimeter	4	[]	Small Fixed Glass	1	[]
Left Side Panel Piece	2	[]	Heater Guard	1	[]
Right Side Panel Piece	2	[]	Door	1	[]
Back Panel Piece	2	[]	Door Handle	1	[]
Door Hinge	2	[]	Upper Bench	1	[]
			Lower Bench	1	[]
			Screw Pack	1	[]

VERY IMPORTANT

Have you got everything? If not please contact the Insignia directly on **01908 317 512**. Remember **NEVER** book your tradesman until everything has arrived, been checked and is present. No replacement/missing parts can be obtained free of charge during or after the build. Any claims can only be within the timescale permitted (48 hours after delivery) and always **BEFORE** build.

Step 1 — Roof Connection (Base)

Locate the 2 roof panels and lock them together via the slot and lock mechanism. You may require a mallet to fully locate them tightly in to position.

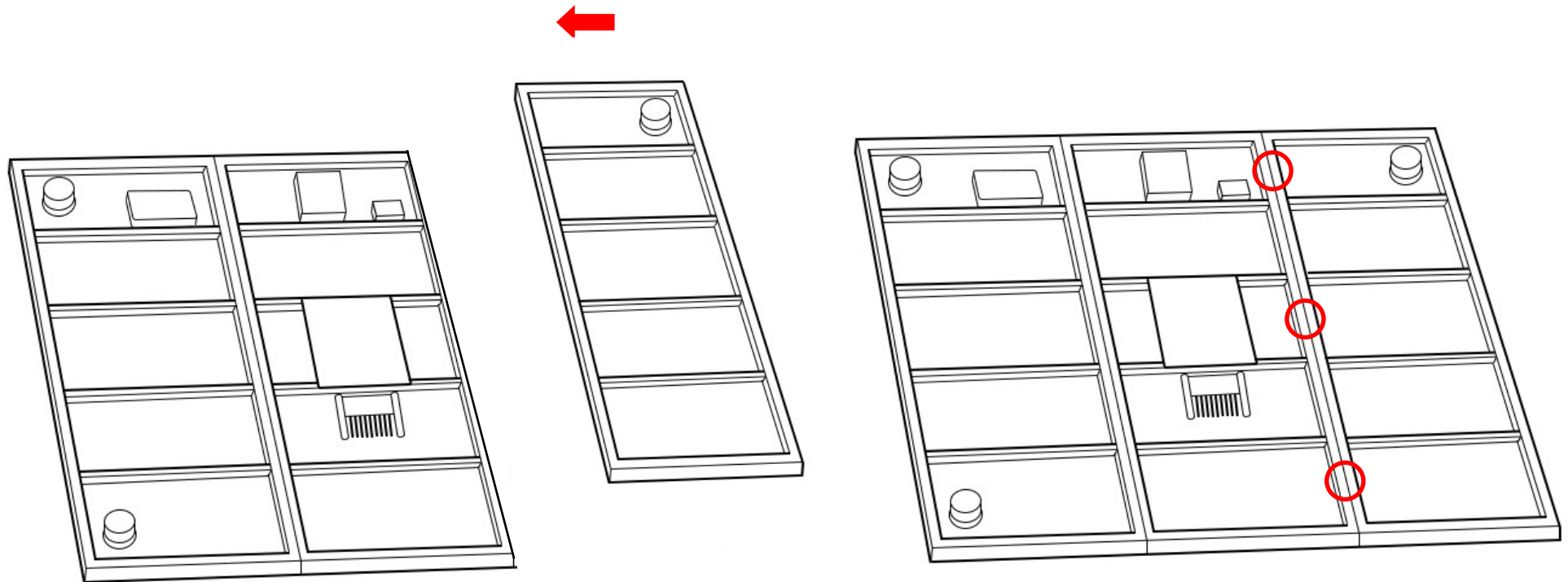

Step 2 — Roof Connection (Outer Square)

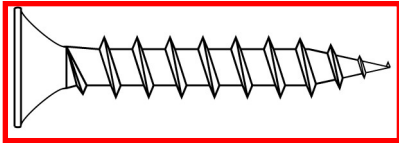

8 x 60mm Screws

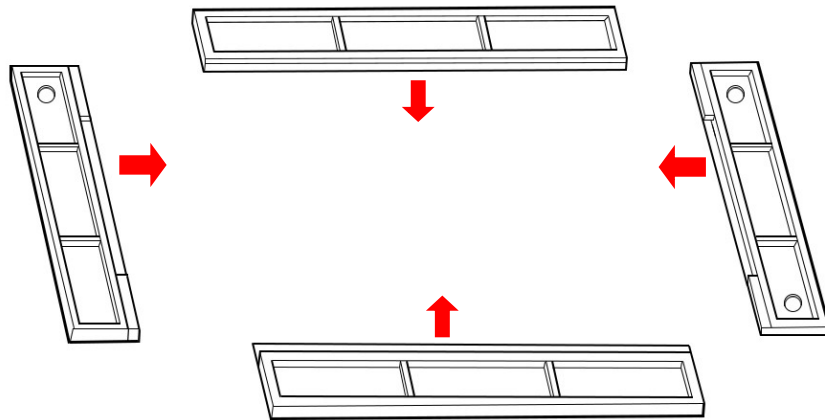

Locate the 4 outer roof perimeter panels and push them together. Ensure the cornice all align on the inside of the construction. Screw 2 x ST60 screws in each corner to secure it together.

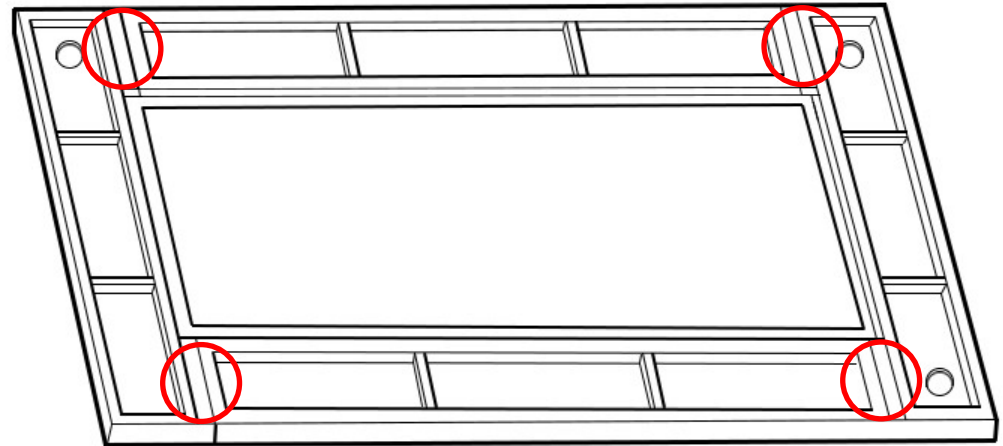

Step 3 — Roof Lights Installation

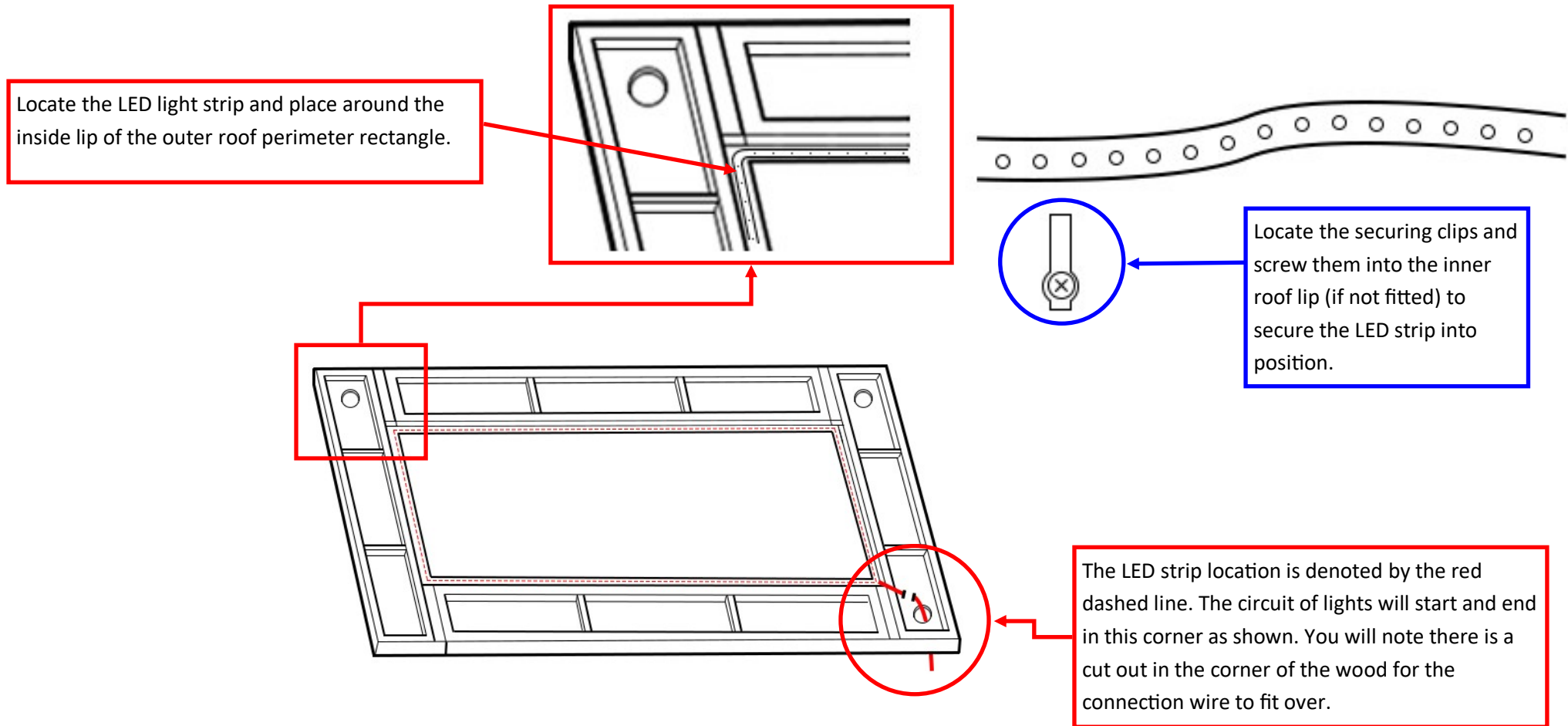

Step 4 — Roof Connection

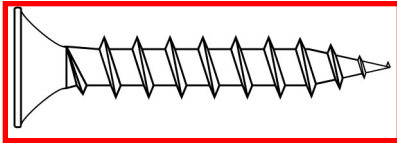

12 x 60mm Screws

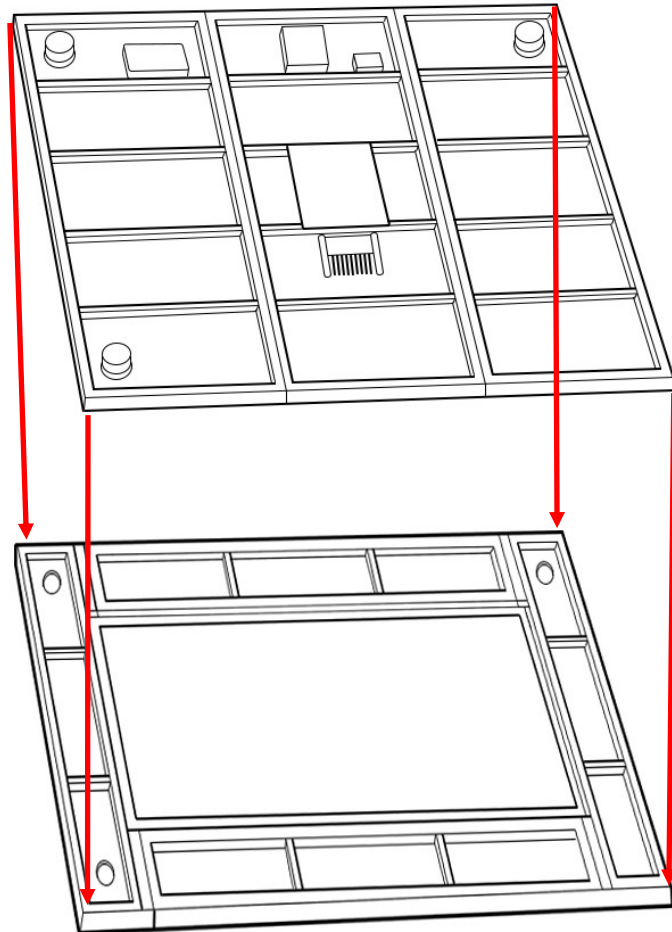

Place the outer roof on top of the inner roof and pass the wire from the LED lighting up through the hole in the corner. Now screw them together using ST60 screws.

NOTE: Ensure the LED wire does not get trapped between the wood and is firmly seated in the channel provided. Failure to follow this could damage the LED light strip.

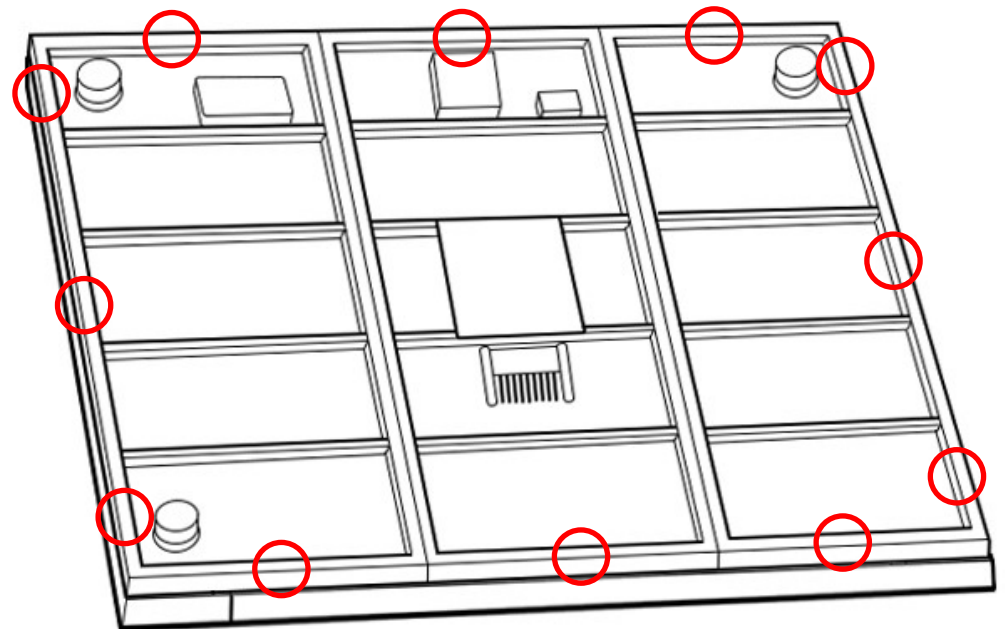

Step 5 — Floor Connection

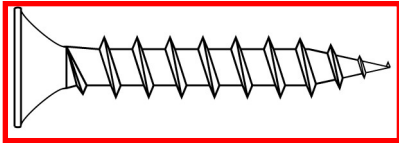

12 x 60mm Screws

Locate the 3 floor panels and push them together. Use 8 ST60 Screws and screw the panels together.

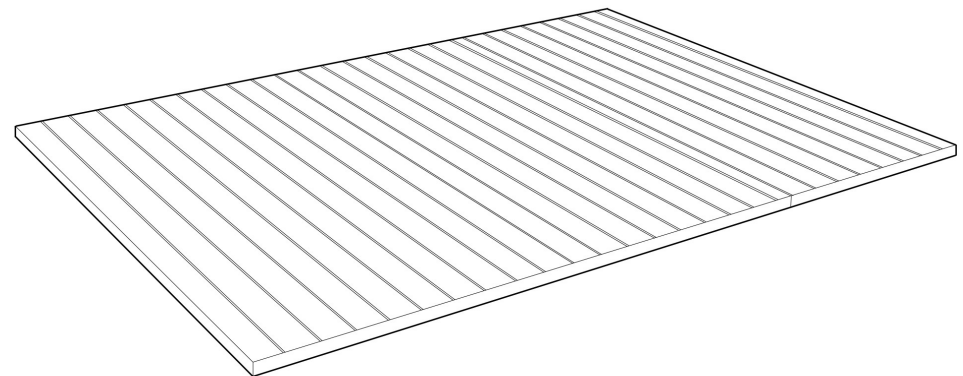
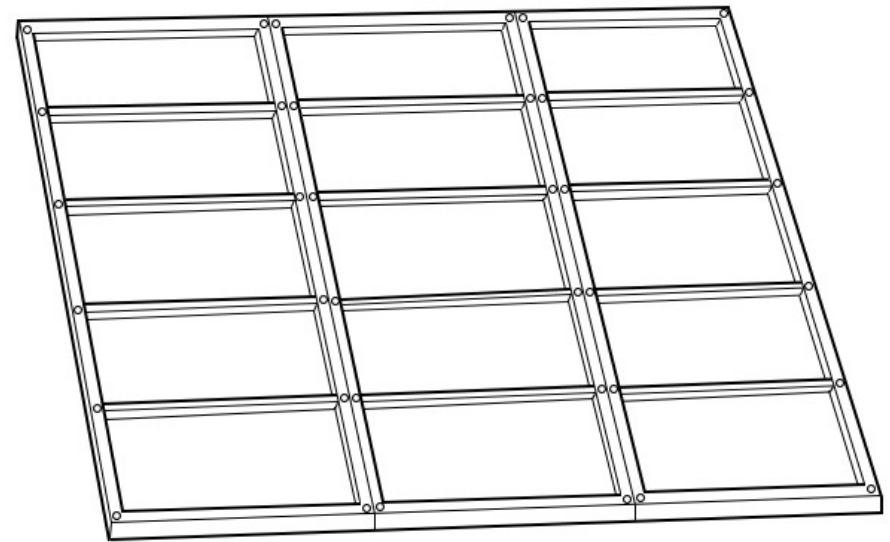
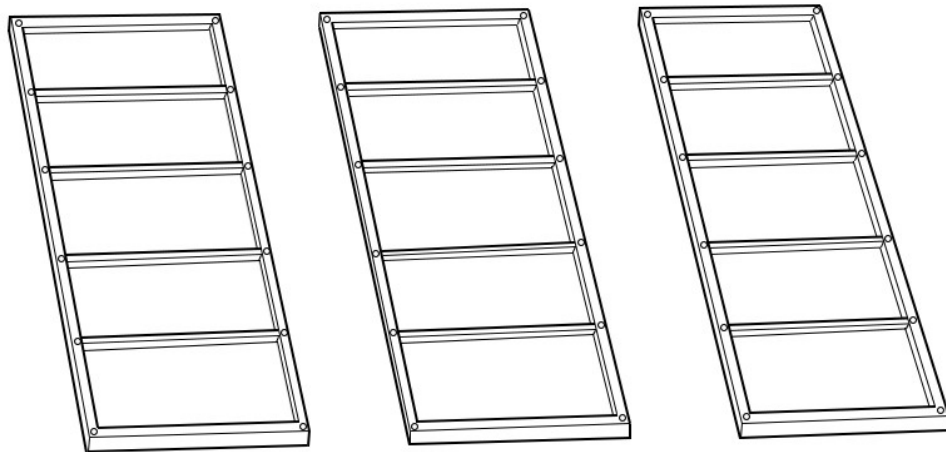

Step 6 — Back panel connection

Locate the 2 back panels and the top/bottom connecting wooden struts.

The top strut has two grooves cut out for wires to feed through.

The bottom strut has plastic feet connected to enable manoeuvrability of the sauna

Push the panels together, interlocking the grooved cut-outs shown.

Tip: Lay the back panels flat for connection.

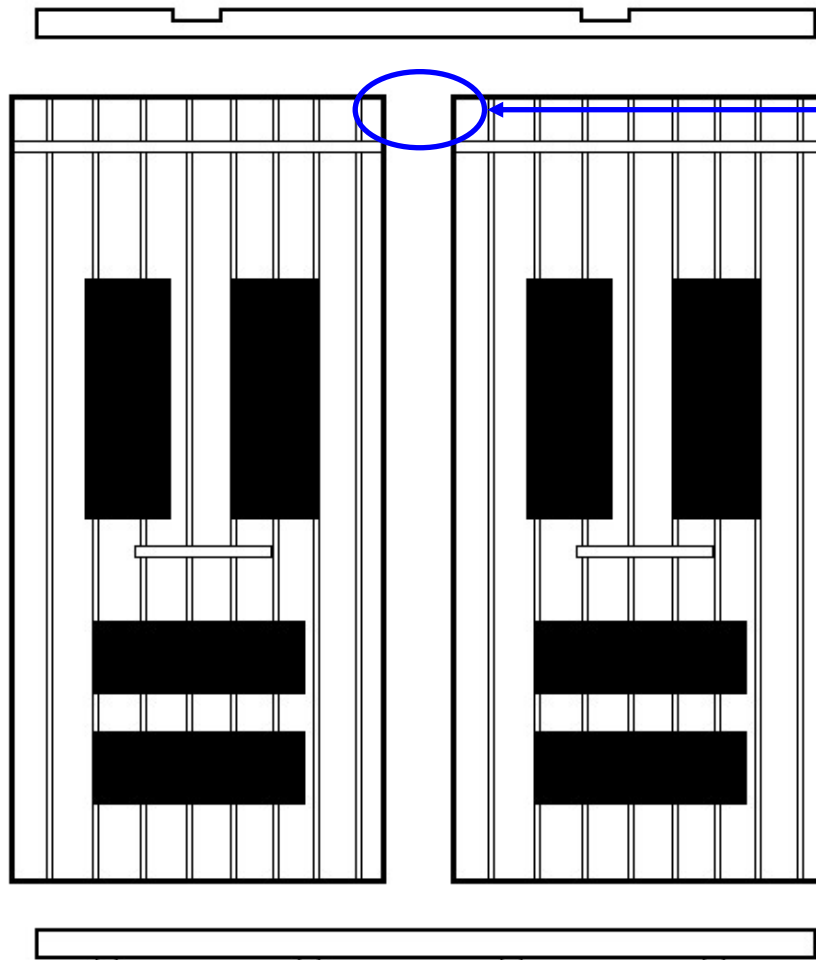

Overhead view

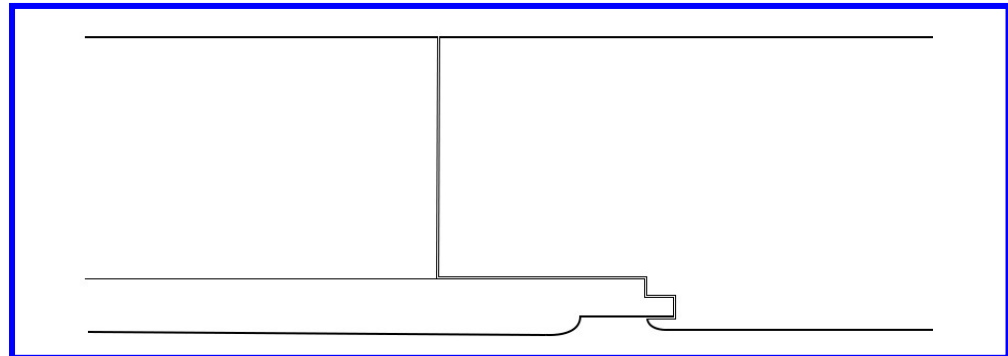
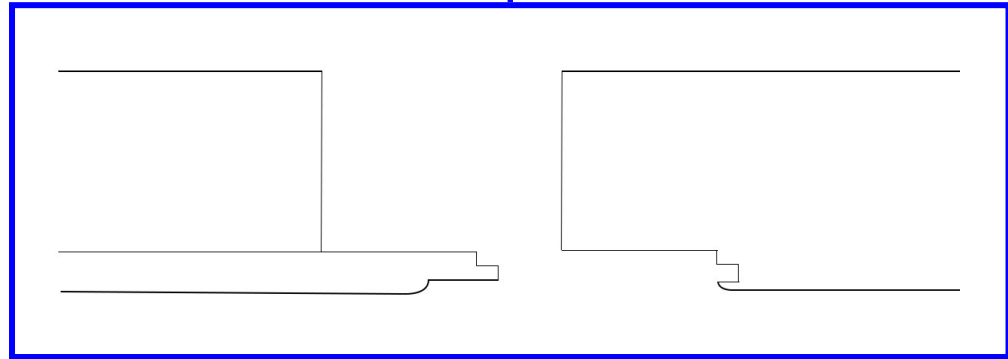

Step 7 — Back panel connection

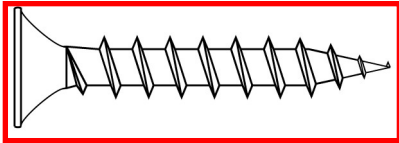

10 x 60mm Screws



Rotate the top strut so the grooves are facing towards the back of the panel.
Push into the connected panels and screw in position using 5 ST60 Screws.

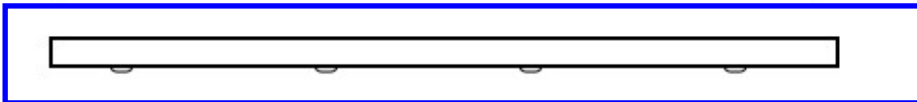
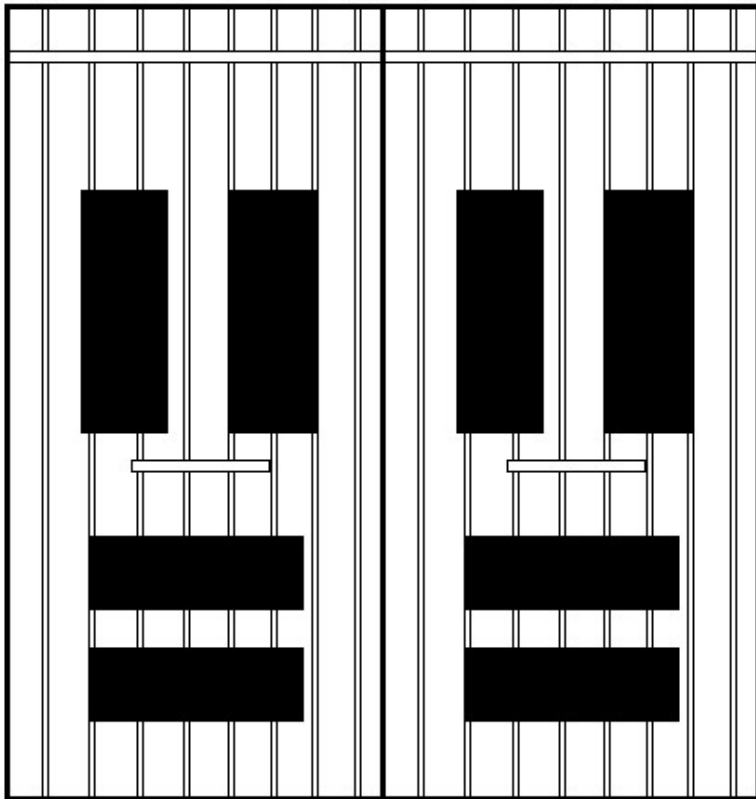

Push the bottom strut into the connected panels
and screw in position using 5 ST60 Screws.

Step 8 — Side Panel connection

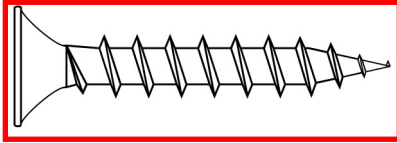

10 x 60mm Screws

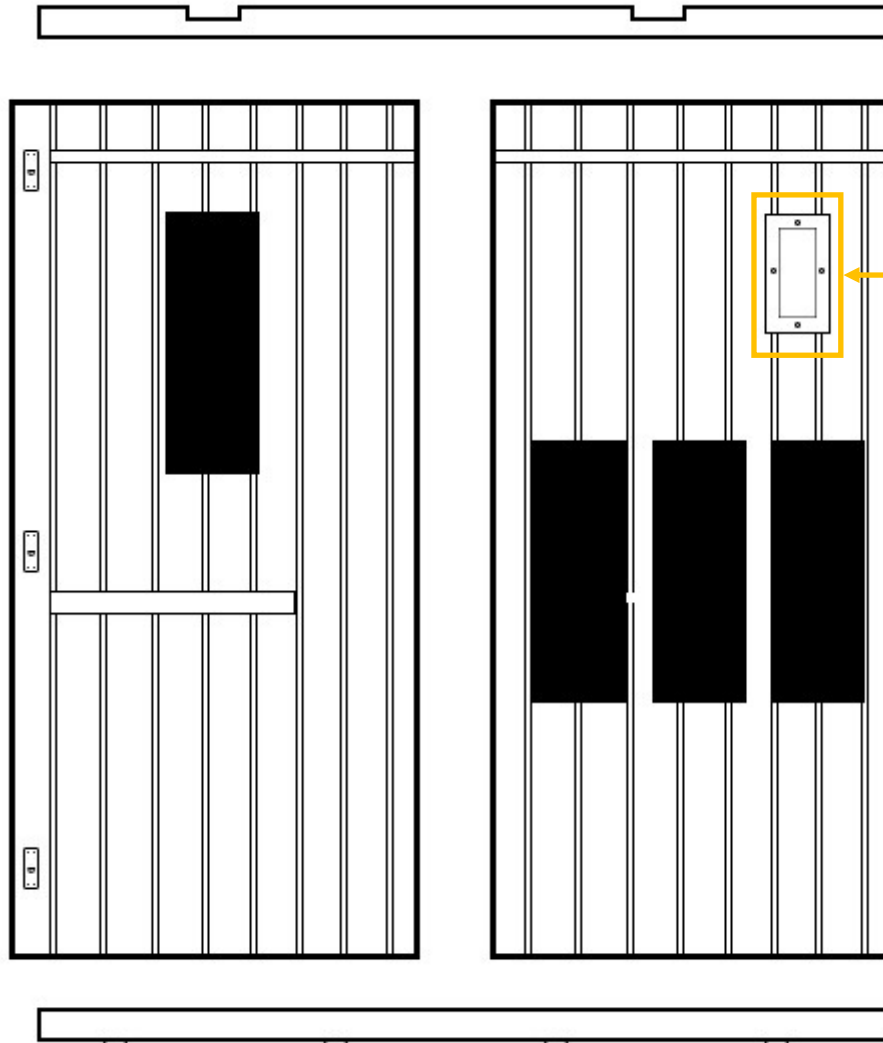

Repeat the process from the previous step for the right hand side panel.

Note the **right** side panel features the control panel.

Once the right panel has been connected, locate the remaining side panel pieces and connect

Step 9 — Connecting right side panel to the back panel.

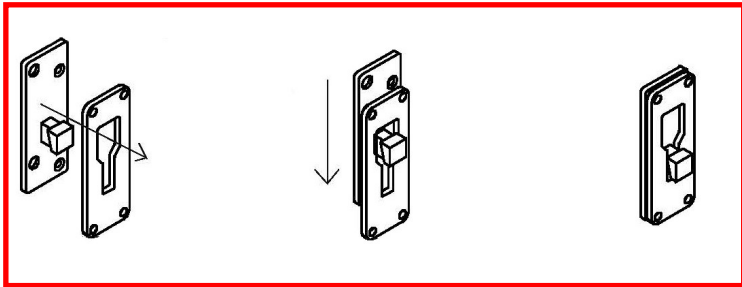

Lift the side panel and locate the connection brackets. Once the brackets have been located, pull down on the side panel to secure into position.

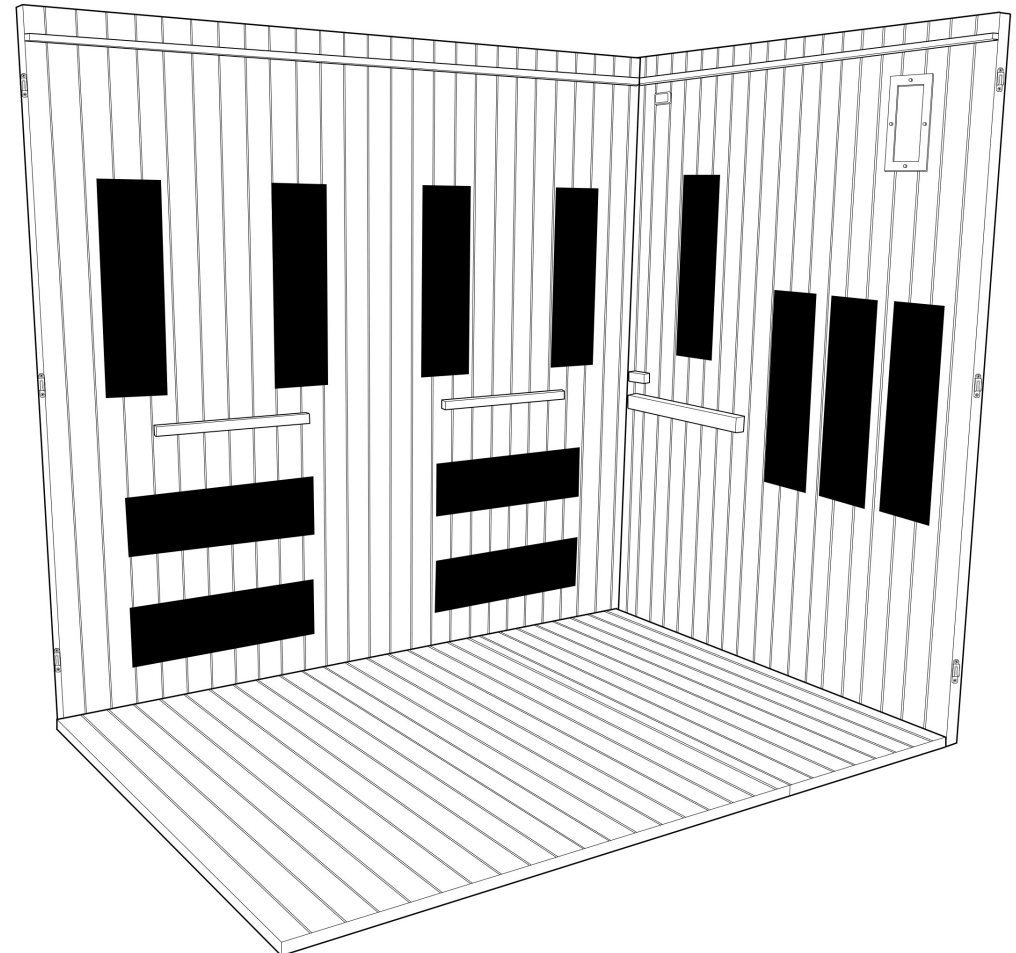
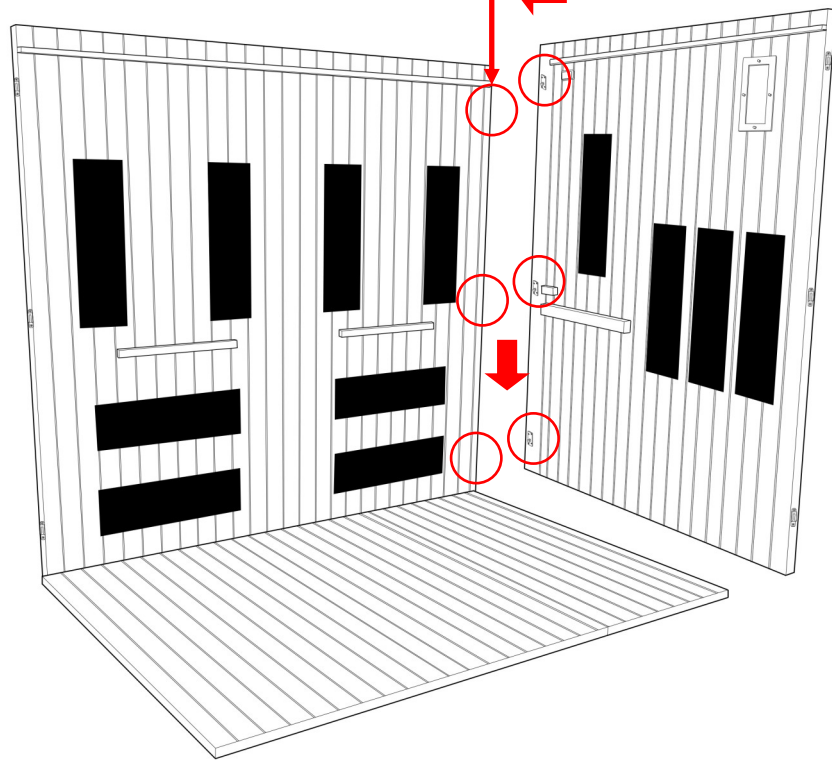

Step 10 — Connecting left side panel to the back panel.

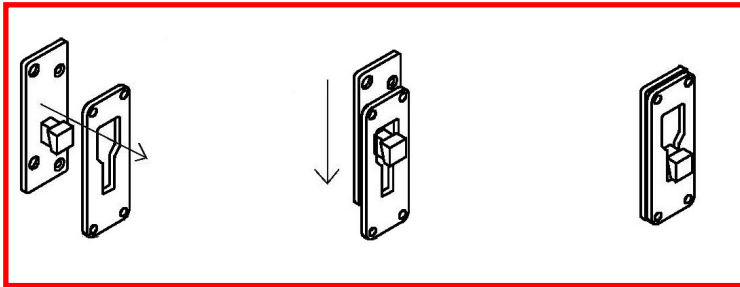

Lift the side panel and locate the connection brackets. Once the brackets have been located, pull down on the side panel to secure into position.

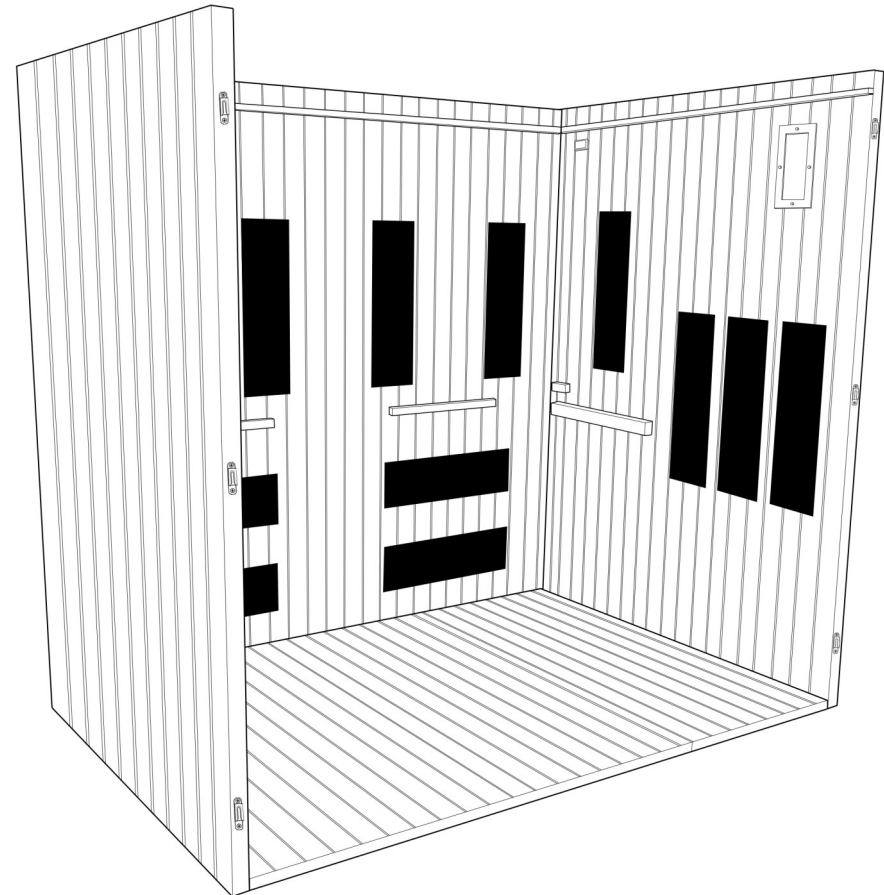
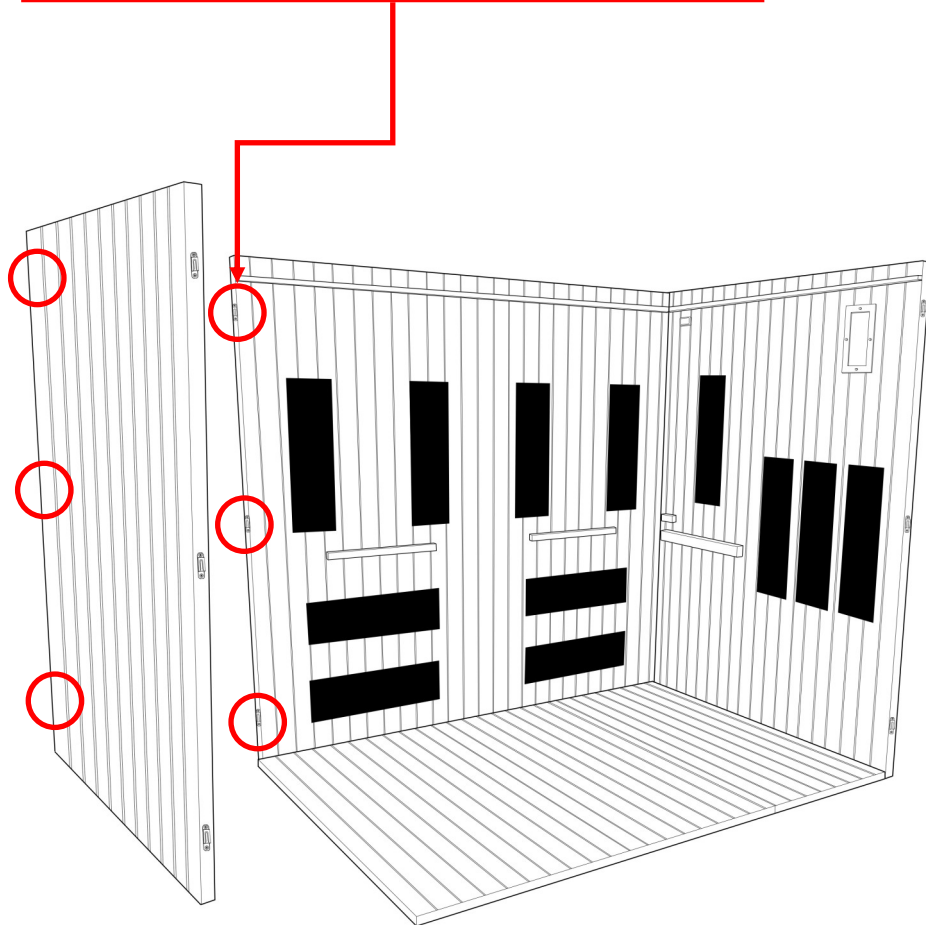

Step 11 — Installing the lower heater guards (back panel)

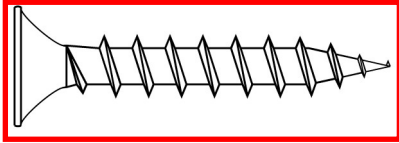

16 x 50mm Screws

Locate the four small rectangle heater guards and fix them to the back panel over the horizontal sauna heaters. Use a spirit level to align and fix in place using 16 x ST50 Screws

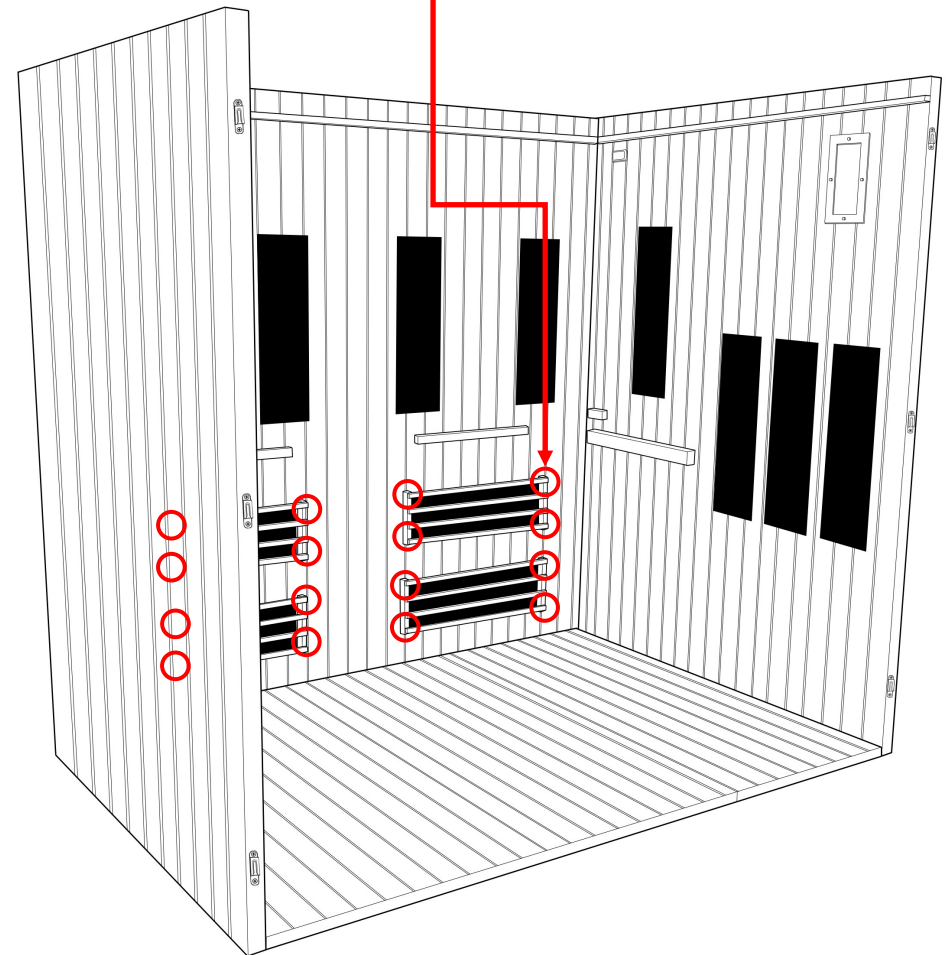
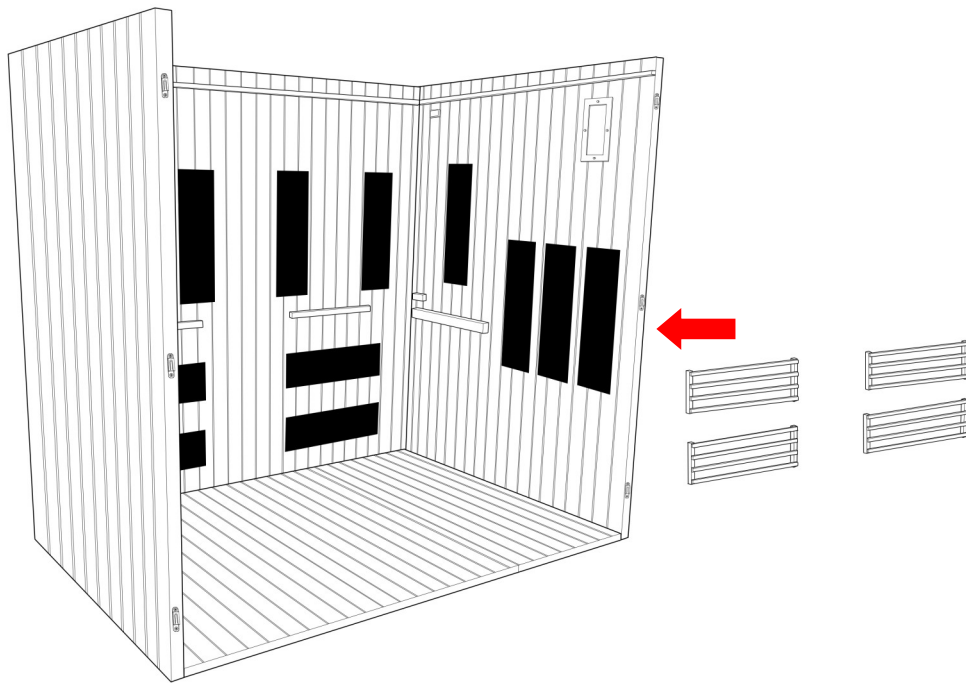

Step 12 — Installing the heater guards (right panel)

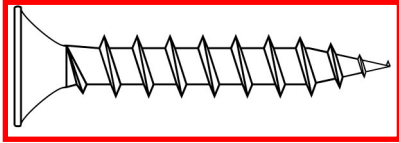

16 x 70mm Screws

Locate the heater guards for the triple heater and single heater, align with a spirit level and screw in position using 4 ST70 Screws per heater guard.

Locate two more single heater guards for the left side panel and secure into position.

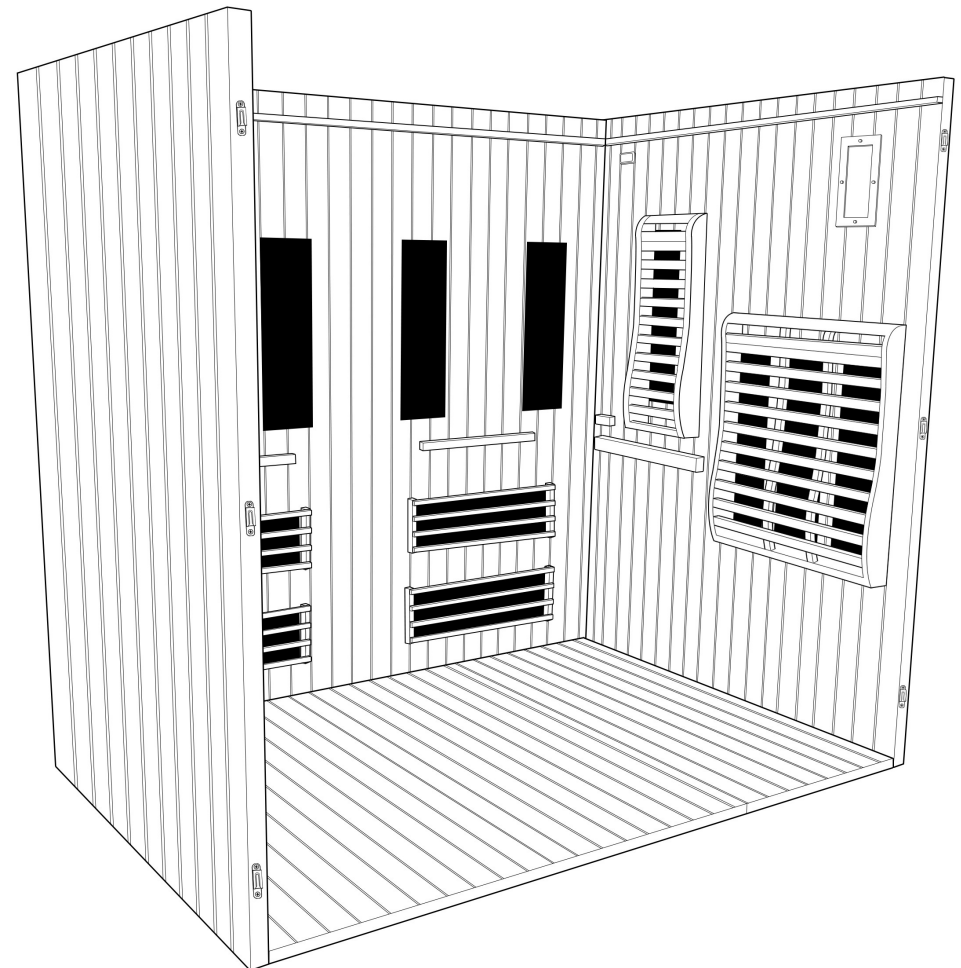
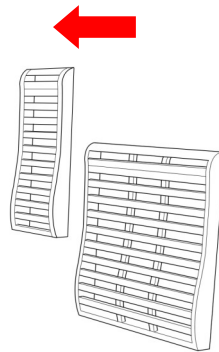
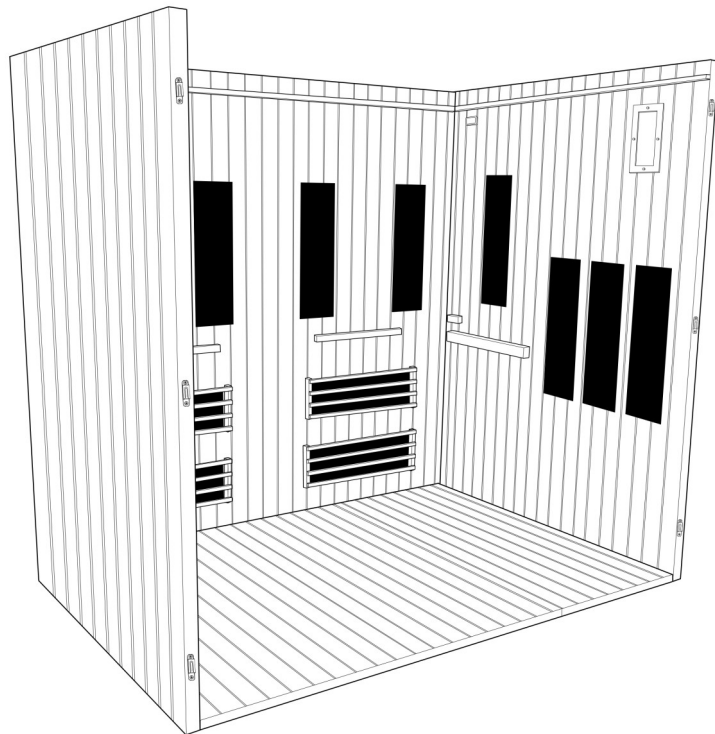

Step 13 — Installing the heater guards (back panel)

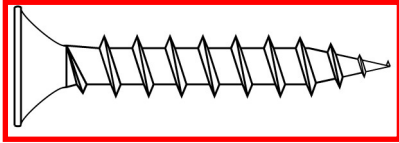

8 x 70mm Screws

Locate the two large heater guards for the double heaters in the back panel, align with a spirit level and screw in position using 4 ST70 Screws per heater guard.

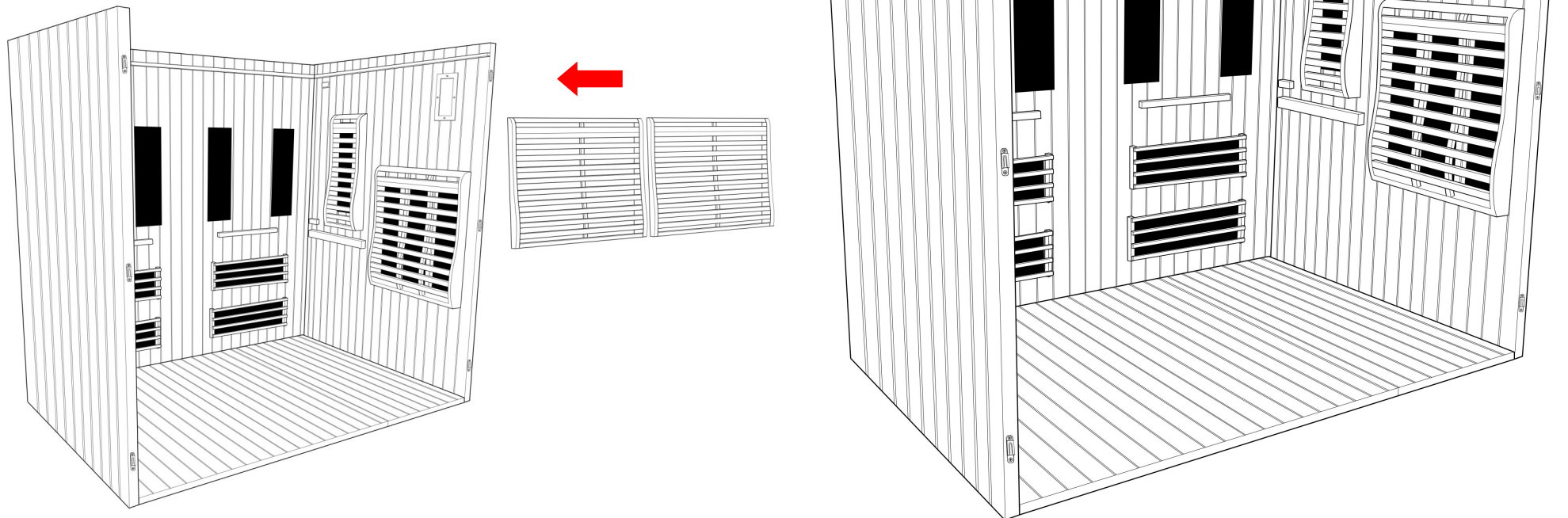

Step 14 — Installing the upper bench

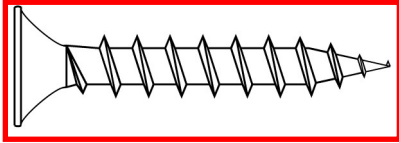

6 x 70mm Screws

Locate the upper bench and slide it into position. The bench will sit on the upper bench supports located on the back panel and each side panel. Once in position secure in place using 6 ST70 screws.

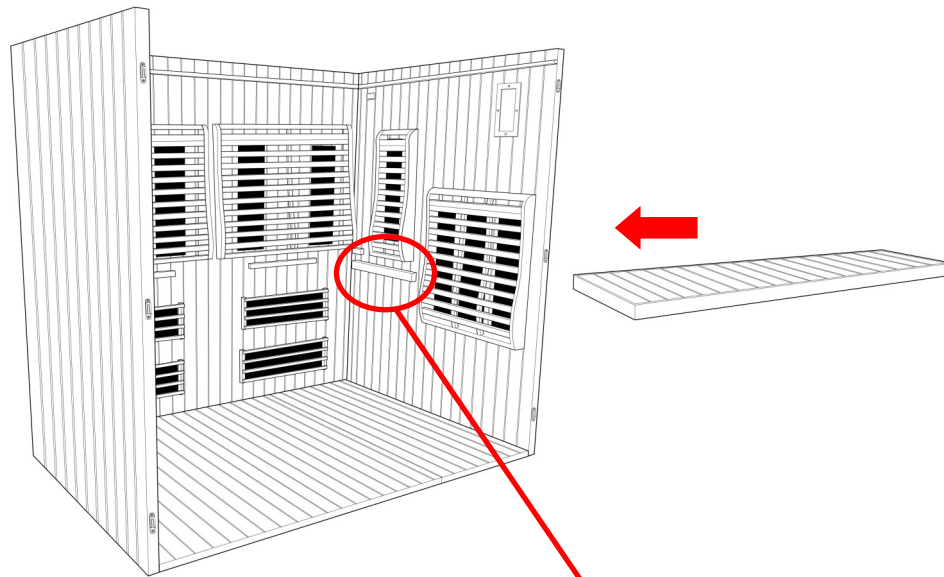

Install the bench baton supports Left/right
689mm from the floor base.

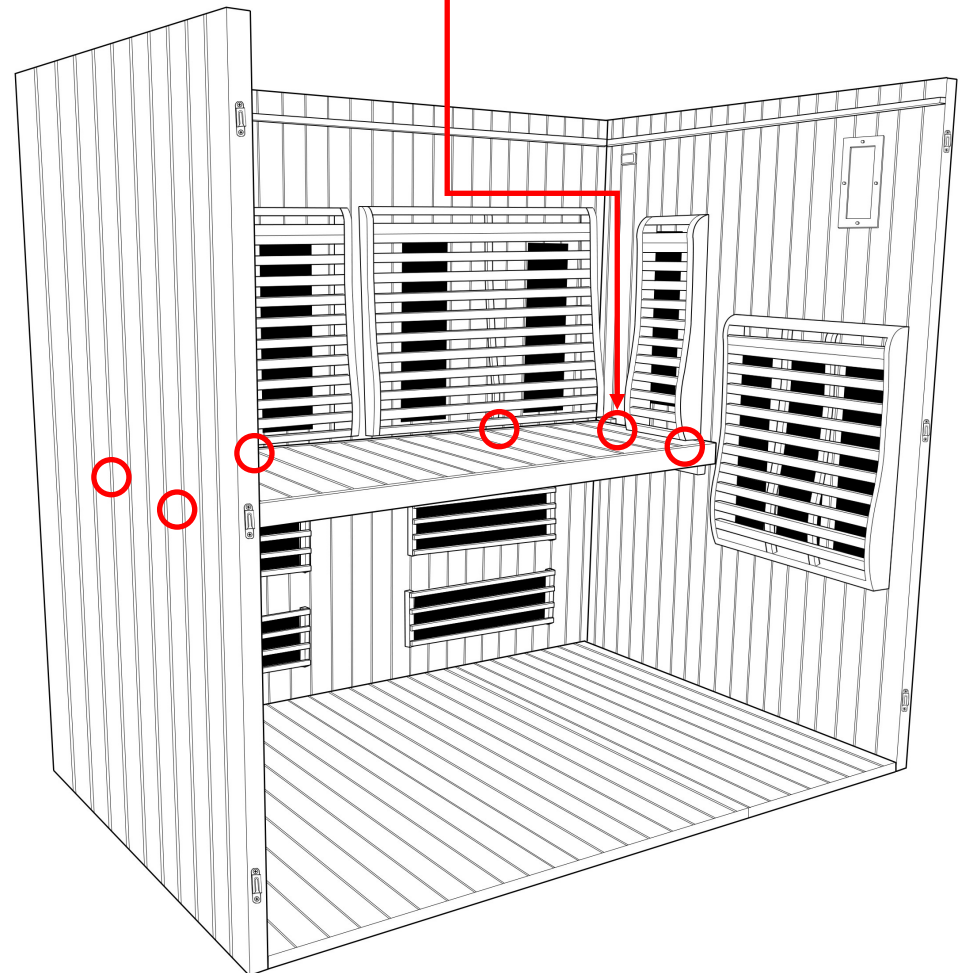

Step 15 — Installing the lower bench support

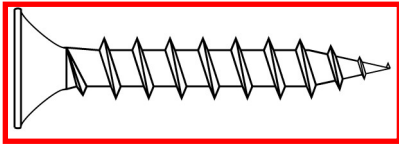

6 x 70mm Screws

Locate the lower bench support beams, align with a spirit level and screw one to each side panel using 3 ST70 Screws. Ensure both supports are positioned at the same height so the lower bench sits flat.

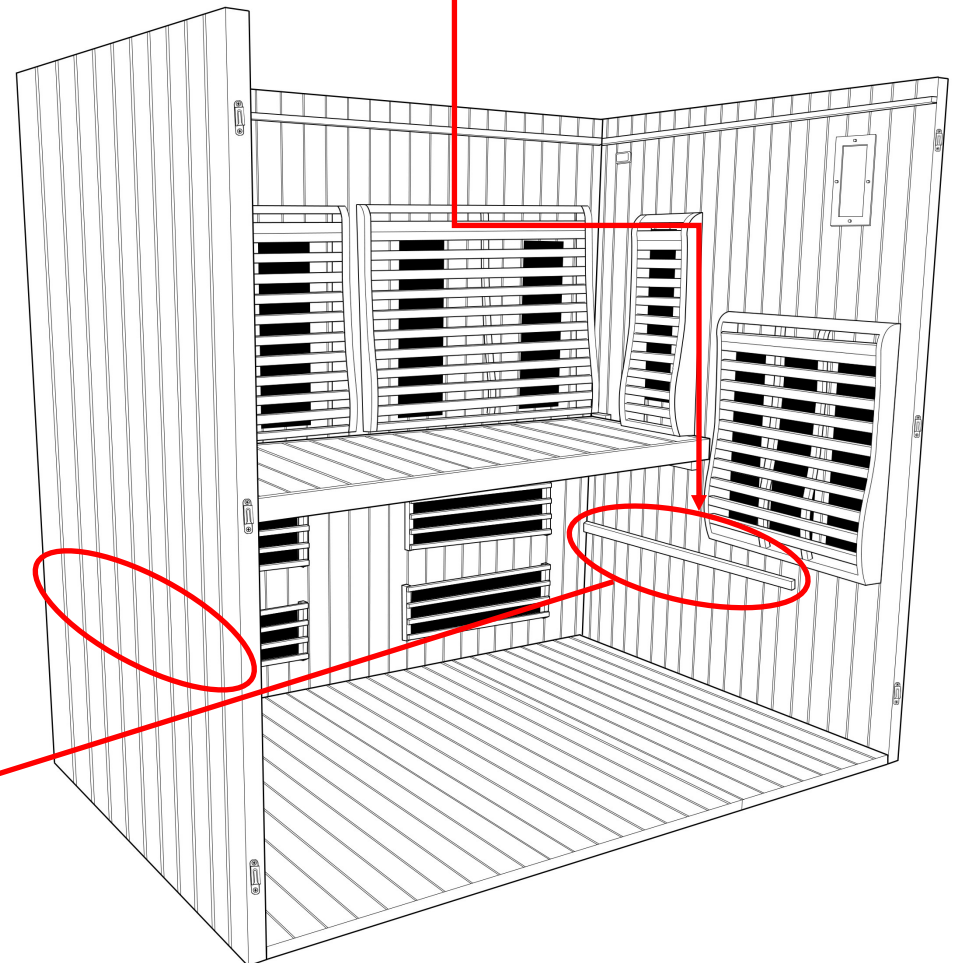
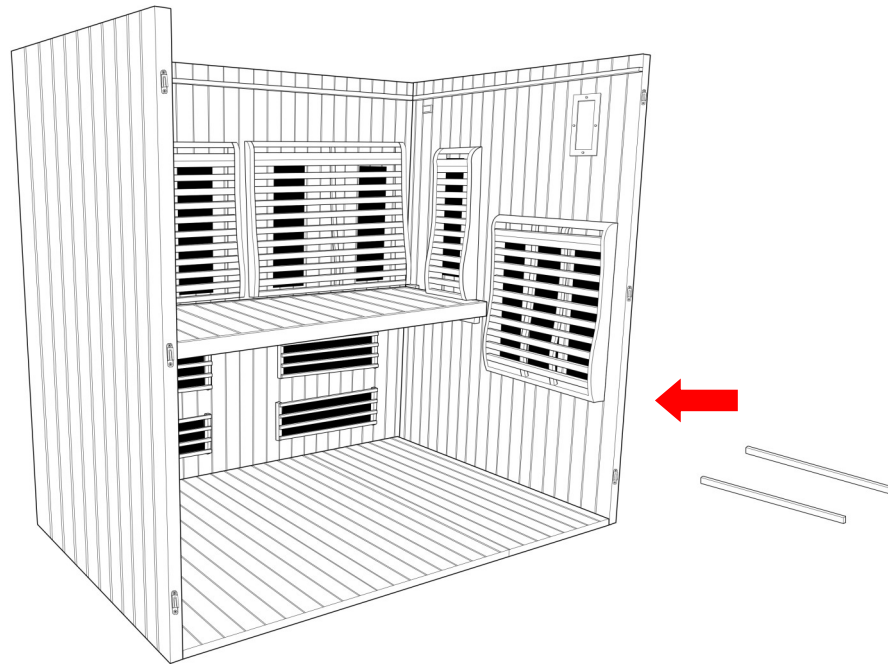

Install the bench baton supports Left/right
287mm from the floor base.

Step 16 — Installing the lower bench

Locate the lower bench and place in position on the lower bench supports. This bench can slide in and out of position to create more room within the sauna if required.

Note: There is a piece of wood which goes behind the lower bench to avoid it sliding back and hitting the lower heaters.

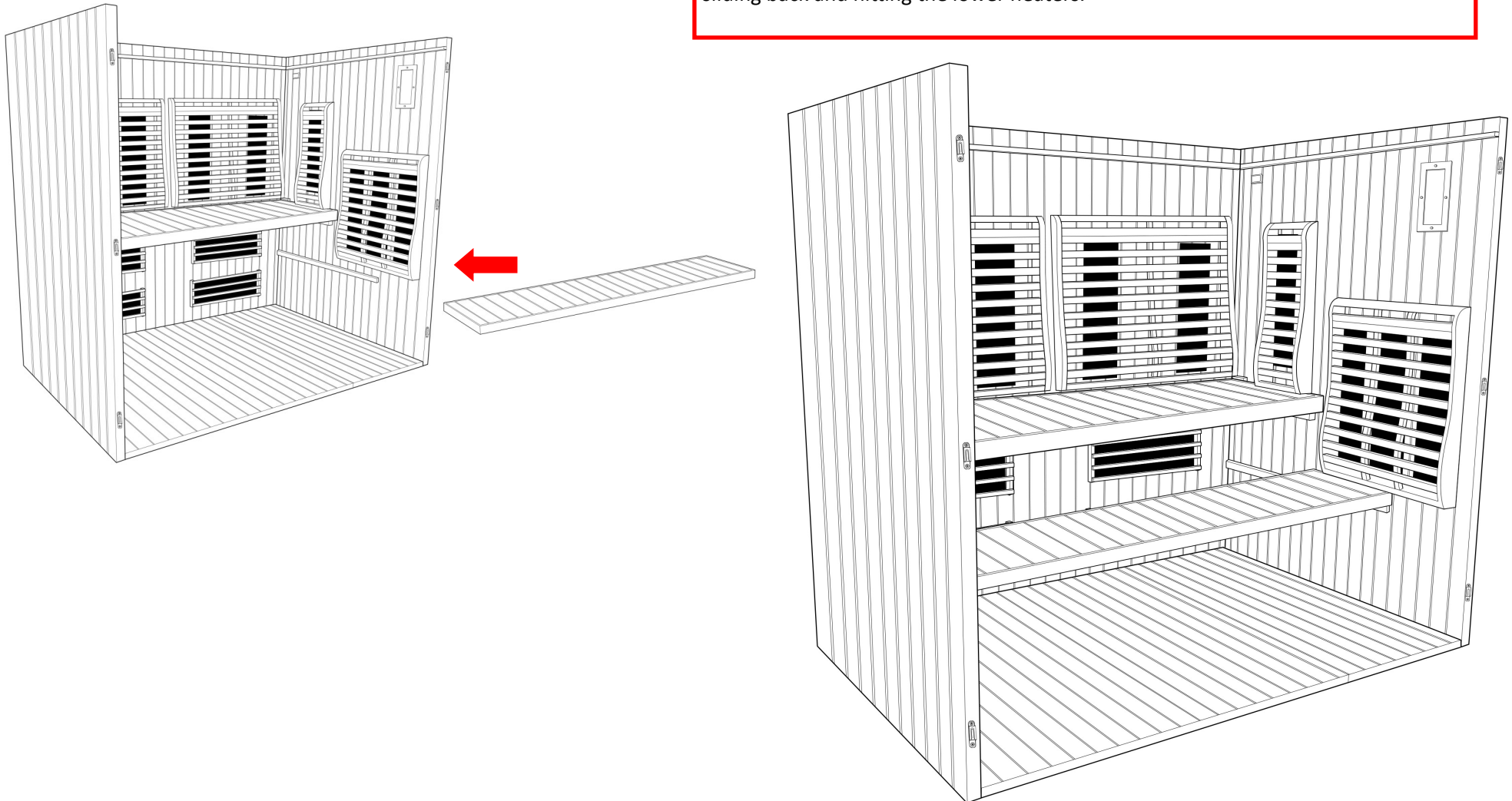

Step 17 — Connecting the front framework

Locate the framework and lay out on the floor face down. Locate the two fixed glass panels and feed them into the cut-out grooves. The top and side framework pieces will have cut-outs for the glass, whereas the bottom the glass just rests on and is secured in position using glass securing clips.

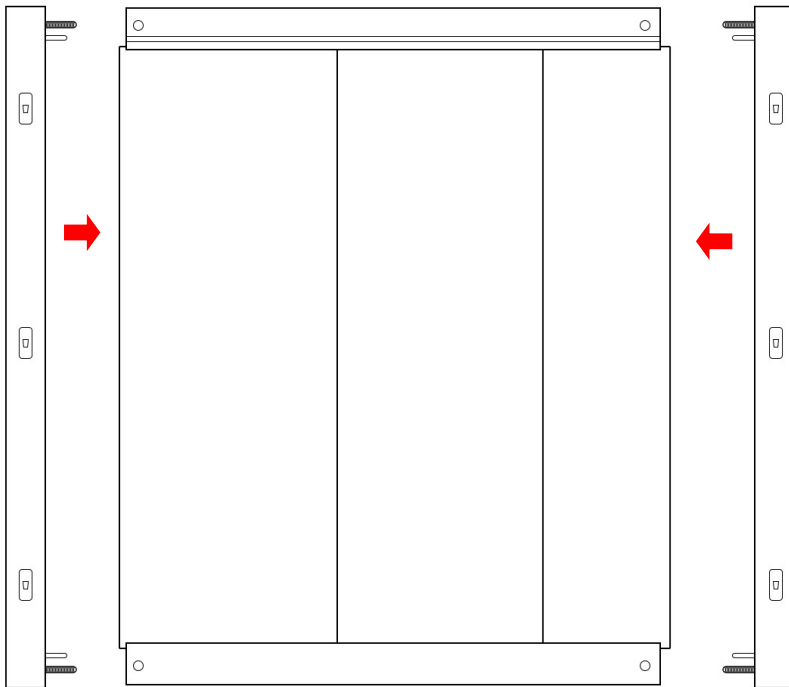

The bolts from the side framework slot into the top and bottom framework and are secured in position using a metal washer, crescent washer and a securing nut. Secure all 4 in place using a spanner.

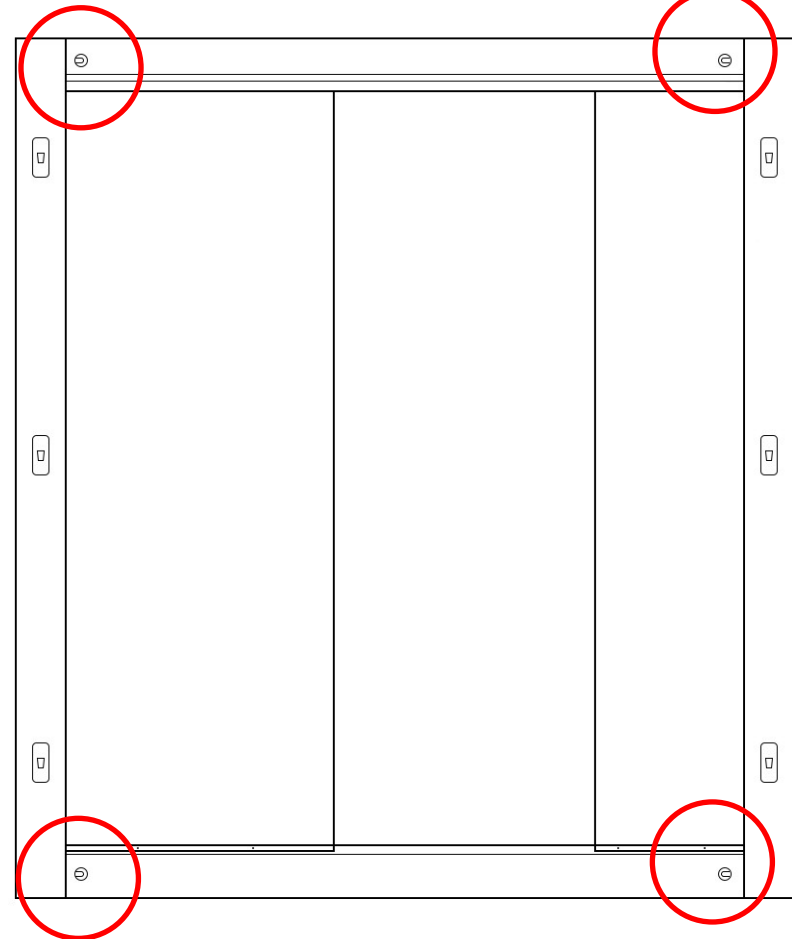
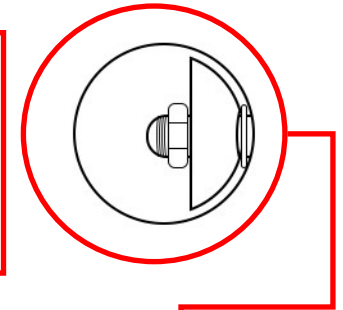

Step 18 — Installing the framework to the sauna

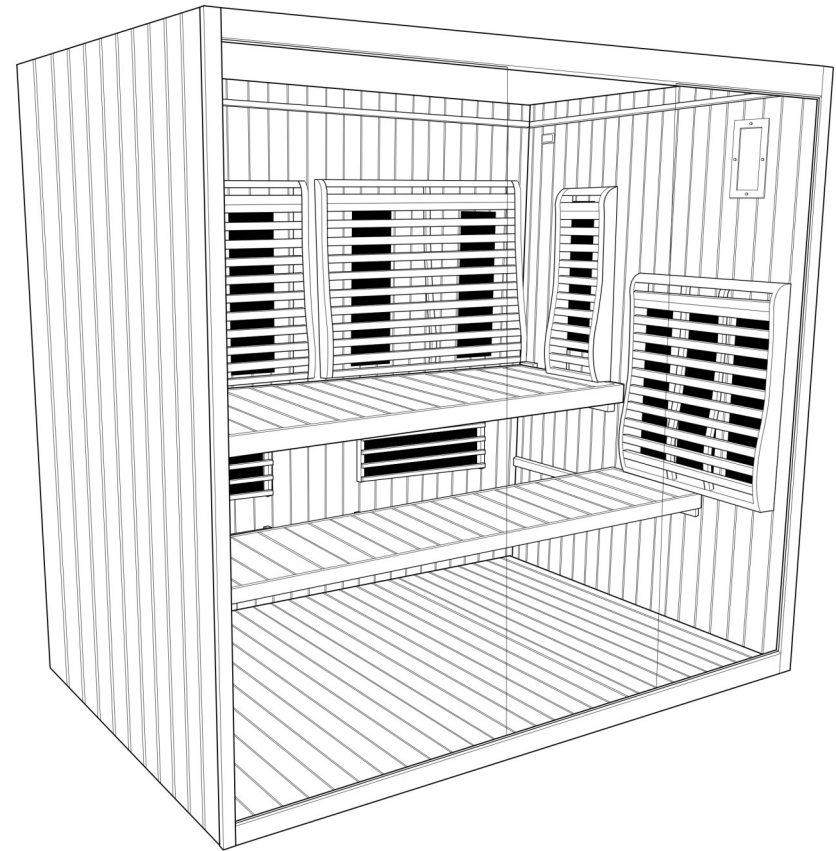
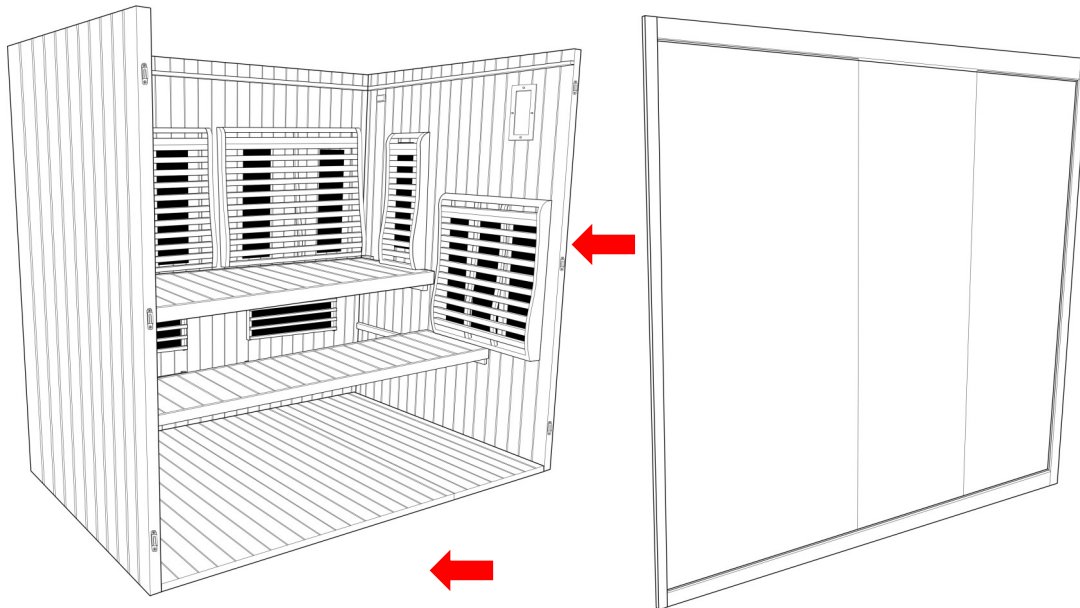
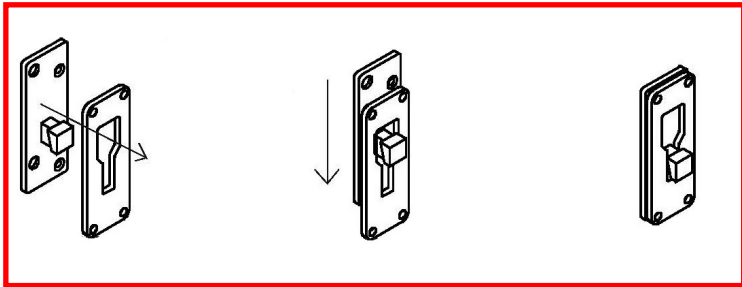

Step 19 — Installing the door handle



Use the Allen key to unscrew the door handle. Unscrew the inner bolt using a screwdriver and separate the entire handle and all the pieces.

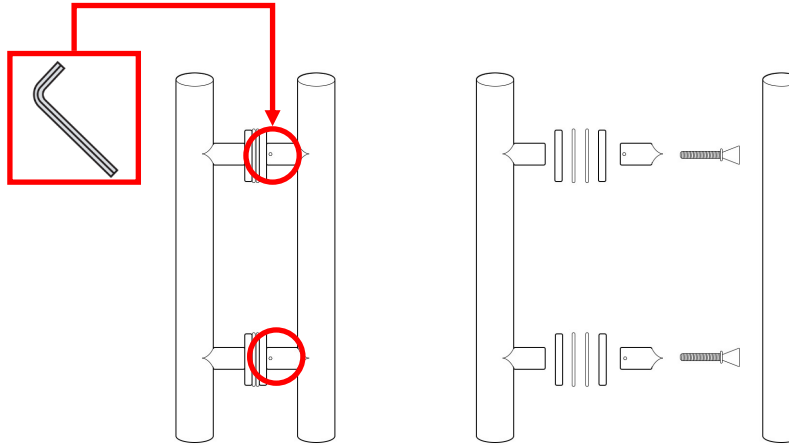

Place the door handle, spacer and washer on either side of the door. Secure in place by tightening the connection bolt within and re-tighten using the Allen key.

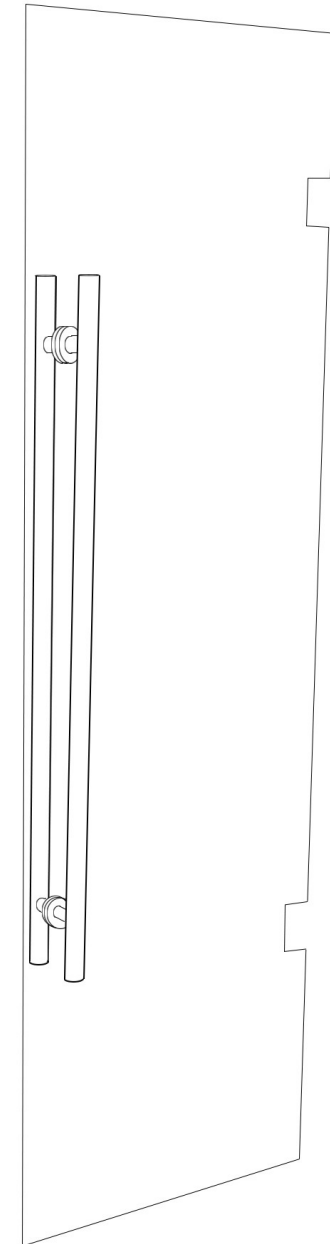
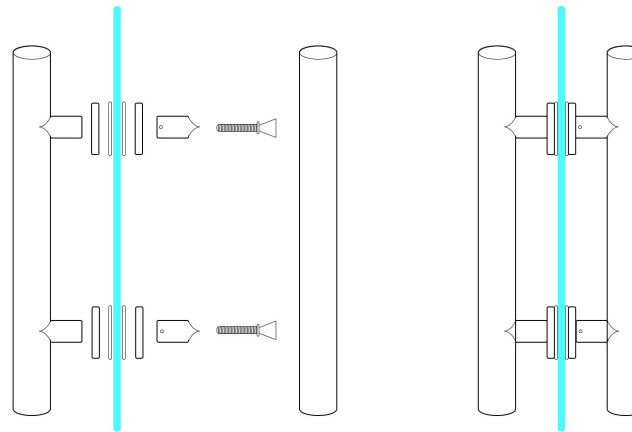

Step 20 — Installing the door hinge

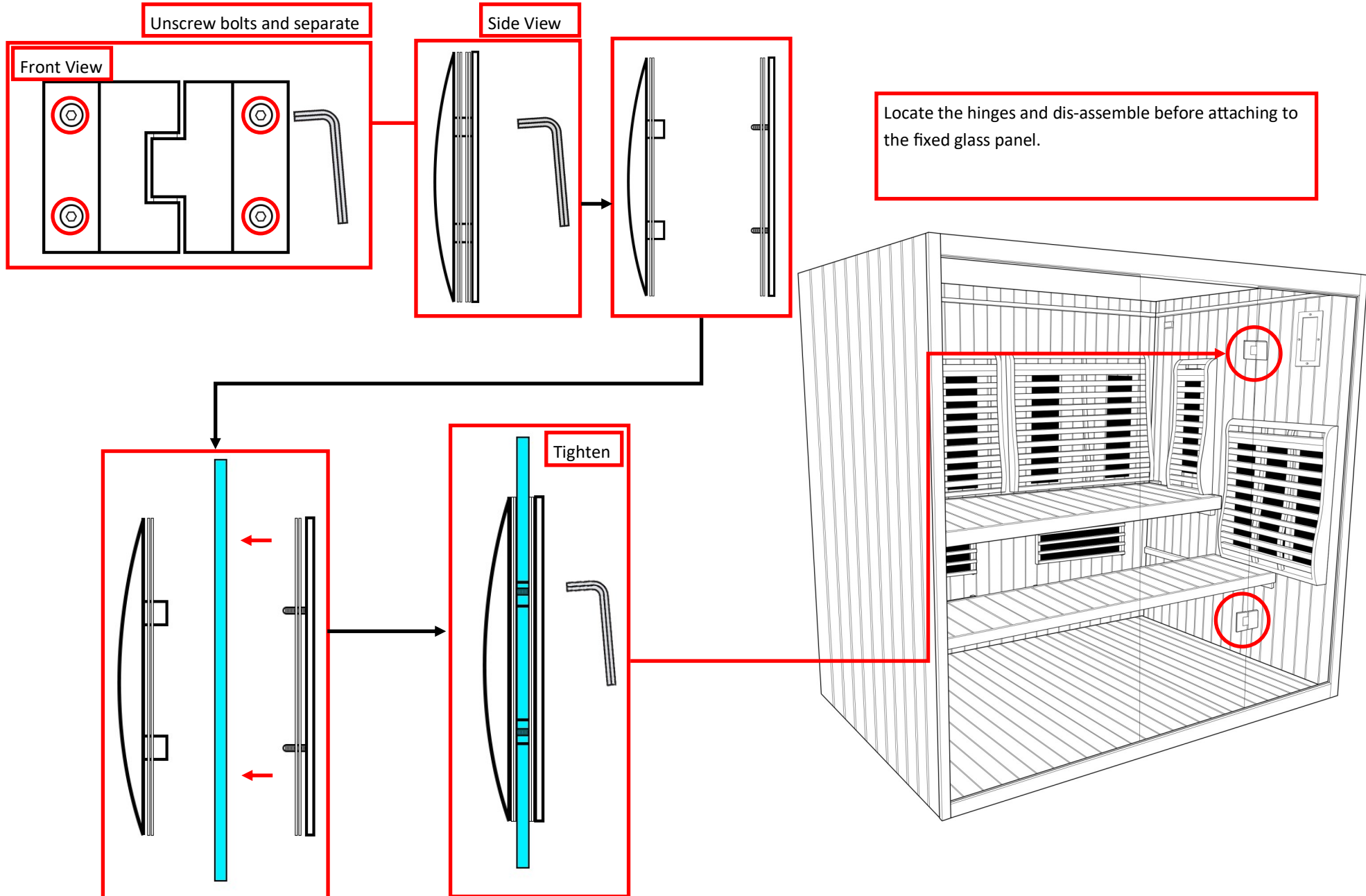

Step 21 — Installing the door

Lift the door into position and then fix the door into the hinges. To realign the door, loosen the bolts slightly, reposition and then retighten. Repeat this process until alignment is perfect.

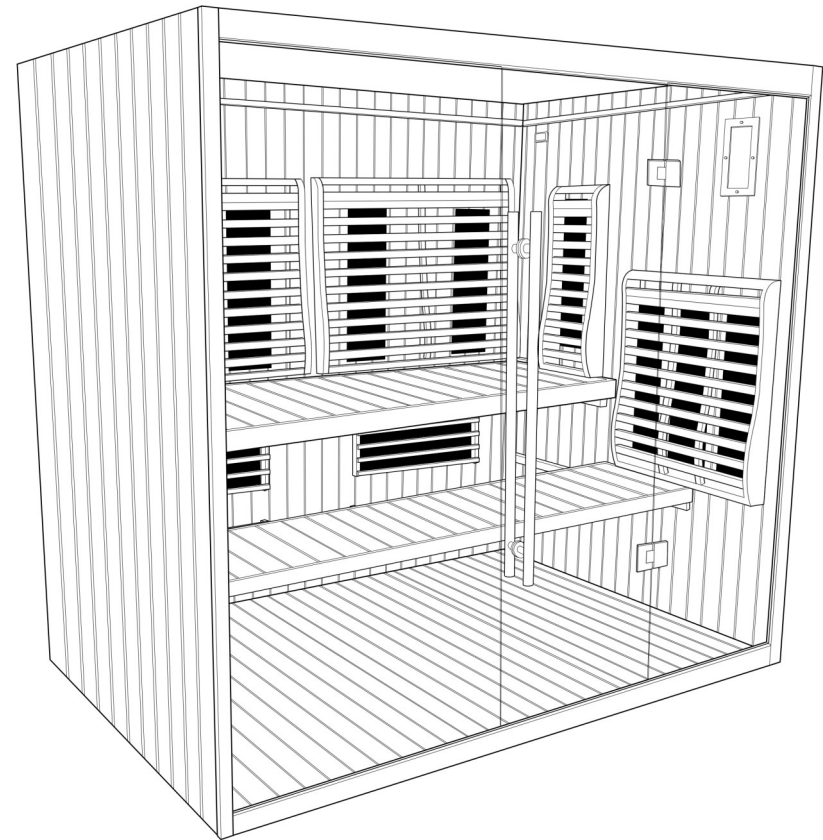
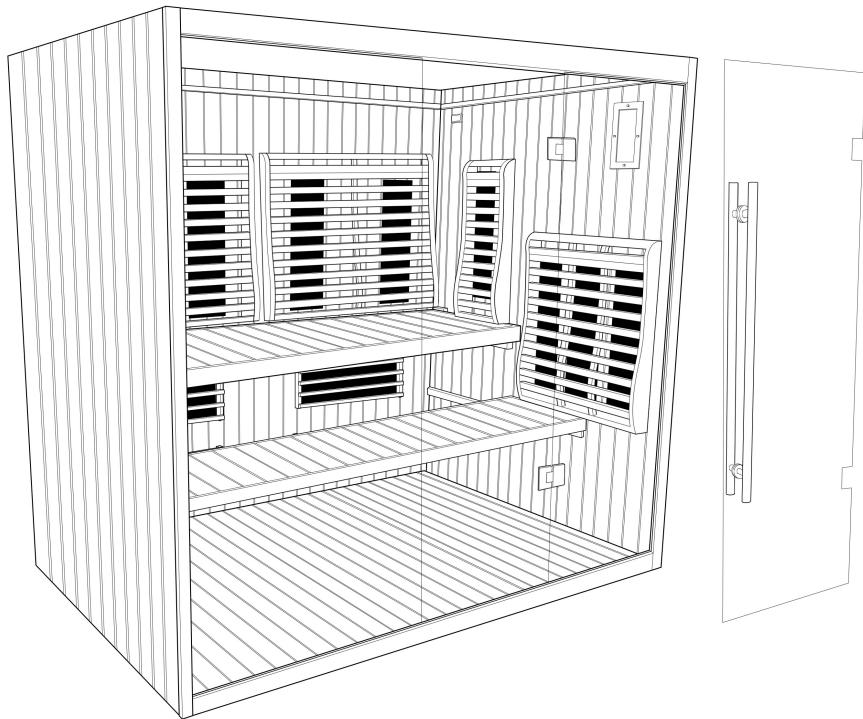

Step 22 — Installing the roof

Lift the Roof and place into the Sauna from above.

Locate the thermos probe and feed through the inner roof. Secure in position using silicone from above.

Ensure the probe extends approximately 75% out.

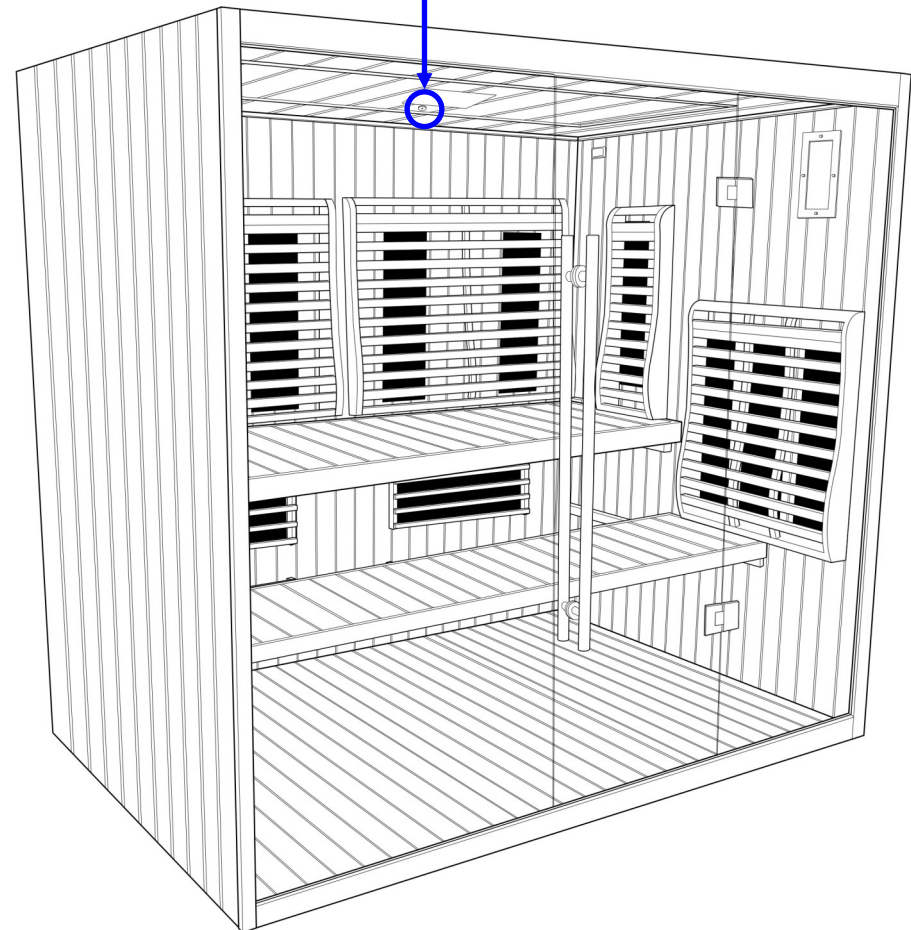
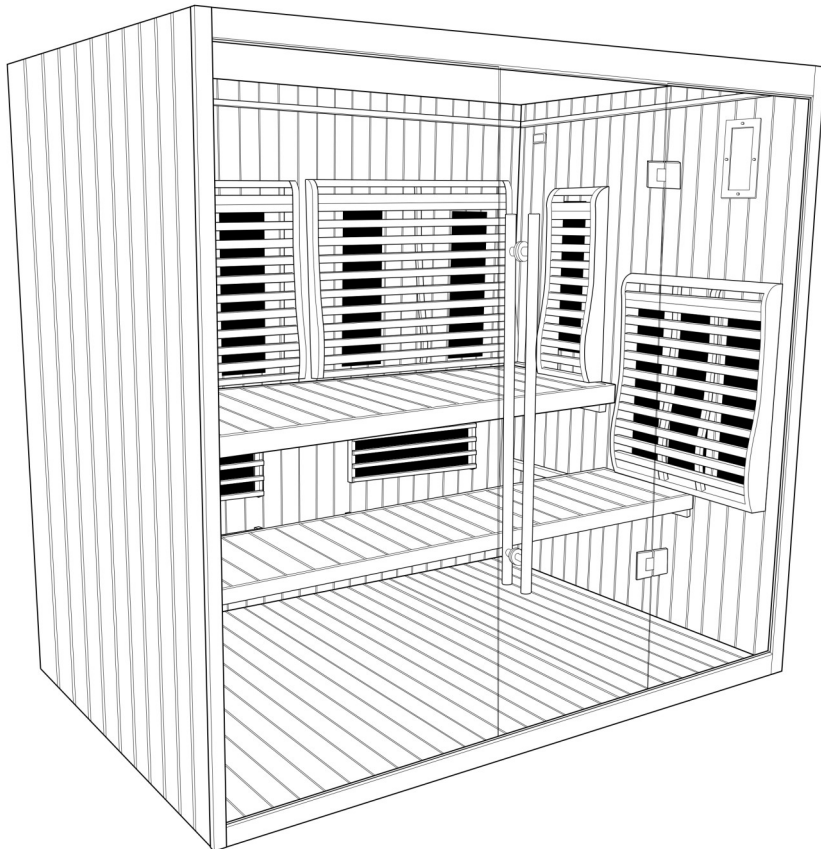
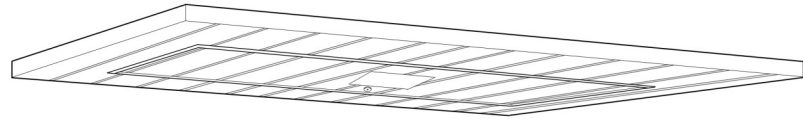
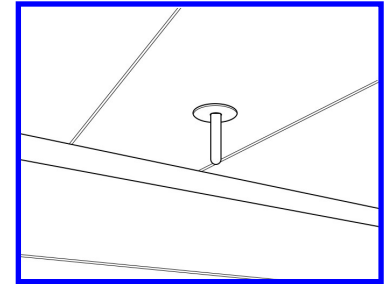

Step 23 — Electrical Connections

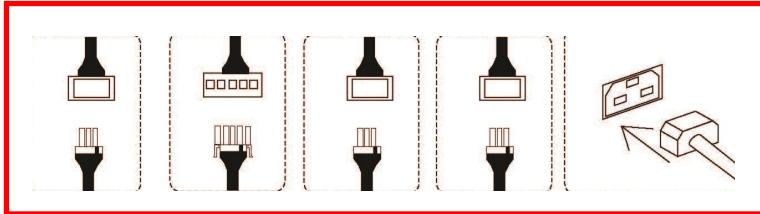

Locate all wires on top of the sauna and connect to the corresponding connection from the wires from the back and side panels.

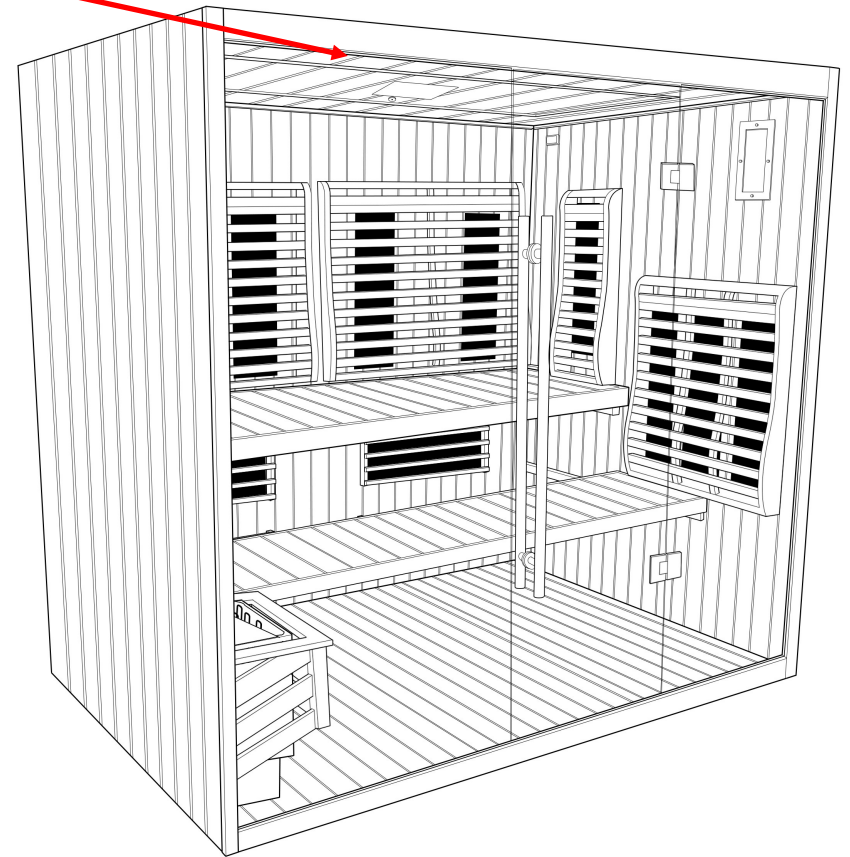

Control Panel Instructions

Button 1/2 (Sauna Heaters)

Press to activate Sauna heaters—ON/OFF

Button 3(Lights)

Press to cycle through the coloured lights. Each press will change colour until a full cycle is completed and they turn off.

Button 4 (Fan)

Press to turn the fan on, press again to turn it to auto and then a third time to turn it off.

Button 5 (Time/Temp)

Press to display temp, then cycle through desired temperature setting (max 60°C) using up and down arrows (Buttons 6/8). Press again to display time, then cycle through desired time setting (max 99 mins) using up and down arrows (Buttons 6/8).

Button 6/8 (Up and Down Arrows)

Use to cycle up or down through various setting options. As standard these operate the volume until other settings are activated.

Button 7 (Play/Pause/Memory)

Use to Play/Pause music through various settings. When searching and tuning the radio, use to save a desired frequency to a specific channel.

Button 9 (Set)

Press and use the arrows (Button 5/11) to manually search. Hold to tune radio stations automatically.

Button 10 (Audio Mode)

Press to cycle through the audio options, Radio/MP3/USB/Bluetooth or AUX.

Button 11 (Alarm)

Press to activate the alarm, press again to deactivate it. Activating the alarm will cause all sauna heaters to automatically turn off.

Button 12 (Power)

Use to power the control panel on or off. Also use to unlock the panel (enters lock mode automatically after 60 seconds of inactivity).

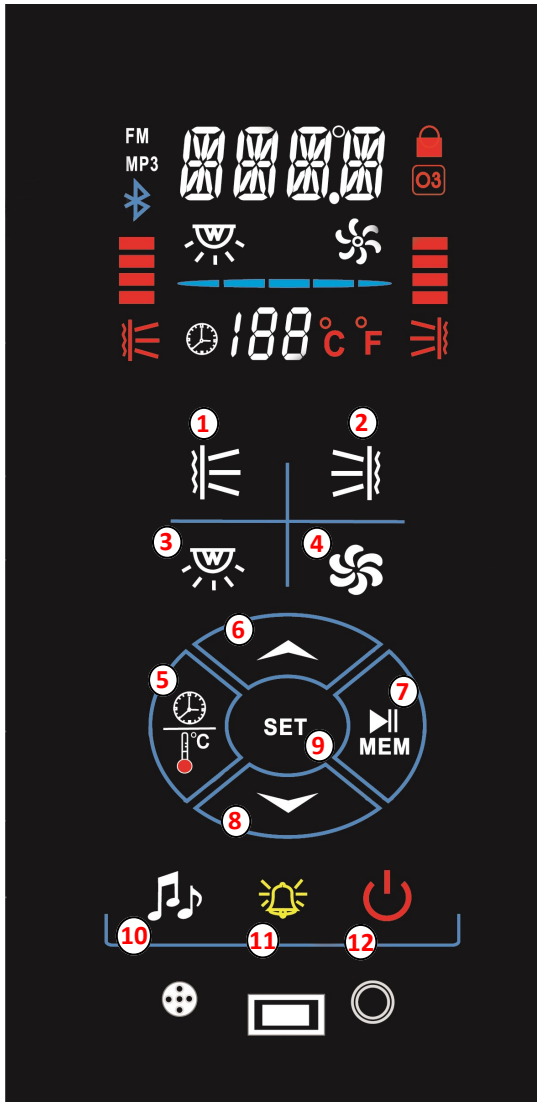

Audio Functions

Radio Tuning:

To tune the Radio hold 'SET' for two seconds to activate the menus. Press 'SET' to bring up manual tuning. Use the arrows to tune to your preferred station. To fast scroll hold the up or down arrow for two seconds. Alternatively, press 'SET' again to activate auto tuning then press the 'Play/Pause' button to begin scrolling.

Bluetooth Connection:

To connect the Bluetooth, press the audio function button a few times until you see the 'bt' menu. Now ensure your device Bluetooth is on and search. Pair with your Sauna and once connection has been made successfully you will be notified by a connection tone and the Bluetooth symbol will appear on the control panel interface. In order to change track, press 'SET' and then use the up and down arrows accordingly.

USB:

Plug your USB device in and press the audio function until you get to the MP3/USB setting. The audio tracks will start to play automatically. In order to change track, press 'SET' and then use the up and down arrows accordingly.



Sauna Usage & Safety Guide

1. Never leave children unattended in the Sauna.
2. Regulate (if preferred) the temperature of sauna or steam before session - Pre-heat time 15-30 minutes (from room temperature 20c)
3. Never touch the heater panels whilst in operation, possible burning may occur.
4. Recommended time of use is a maximum of 15 mins initially. We highly recommend working up in time to this, beginning with 5 minute sessions to get your body used to using a sauna.
5. Suggested operational heat range: Infrared—30° C-40° C. Infrared optimum use range 35°C to 40°C
6. Stay hydrated during each sauna session.
7. Exit the sauna immediately if feeling dizzy, faint or short of breath.
8. Do NOT use the sauna function if you're pregnant, have a heart condition, have low or high blood pressure. If you're unsure consult your GP before use.
9. If you have any underlying health conditions which you feel could be aggravated by an increase in temperature, consult your GP before use.
10. If you begin to have any issues with your health after using a sauna, stop immediately and consult your GP regarding your symptoms before continuing to use.
11. Consult your GP before using the steam room if you're on medication at all, especially with drowsy side effects.
12. Never use the sauna if you have been drinking alcohol or under the influence of other substances.
13. Do not put combustible material on the heaters at any time.
14. Always turn power supply off after use.

WEEE Compliance Statement

The UK Waste Electrical and Electronic Equipment (WEEE) regulations came into force on 2 January 2007. Under this new legislation, producers of electrical and electronic equipment (EEE) have to fulfil certain obligations.

Under the WEEE directive Insignia is considered the producer of certain products we supply and in line with the demands of the legislation we are pleased to offer the opportunity to return these products to us for treatment and recycling.

Insignia products will generally have an identifying mark and the common crossed out wheelie bin label. We accept returns of all products carrying the Insignia brand. All other products are either considered outside the scope of WEEE or Insignia is not technically the producer of these products. Insignia also accepts historic like-for-like WEEE returns. All WEEE returned to Insignia will be recycled in appropriate treatment and recycling centres in accordance with the legislation. If you wish to return any products to us, please send your item(s) to our head office.

Company Contract No. 326457

WEEE Producer No. CBDU64227

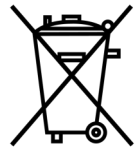

LABELLING

Products labelled with the WEEE symbol (a crossed out “waste bin”) indicate that the final user should not discard this product along with other household waste, but that it must be collected and treated separately.



Returns Address for WEEE

Insignia

9a Deans Road, Old Wolverton, Canon Industrial Park, Milton Keynes, Buckinghamshire, MK12 5NA, UK



EU – Declaration of Performance

Insignia declares that all its products complies with the essential requirements and other relevant provisions of Directive 305/2011/EC. A copy of the Declaration of performance is available from www.insigniashowers.com/ce-certification

Insignia™ is a registered trademark of Maclean International Ltd, 9a Deans Road, Old Wolverton, Canon Industrial Park, Milton Keynes, Buckinghamshire, MK12 5NA, UK

All images are subject to copyright. Images may not be used in any way shape or form with out written permission from Maclean International Ltd. Images are NOT permitted to be saved, printed or uploaded. Violation of copyright laws are punishable by law.

All images are registered with
ImageTraker

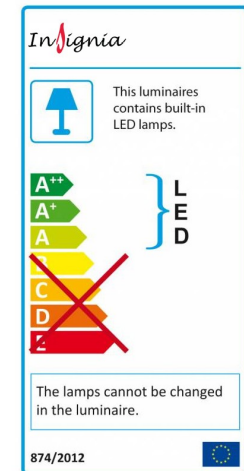

Insignia™ is a registered trademark of Maclean International Ltd

All images are subject to copyright. Images may not be used in any way shape or form with out written permission from Maclean International Ltd. Images are NOT permitted to be saved, printed or uploaded. Violation of copyright laws are punishable by law.